

KIINT.-OY RASTILANTORI  
MERI-RASTILAN TIE 6 D 56  
2.KERROS

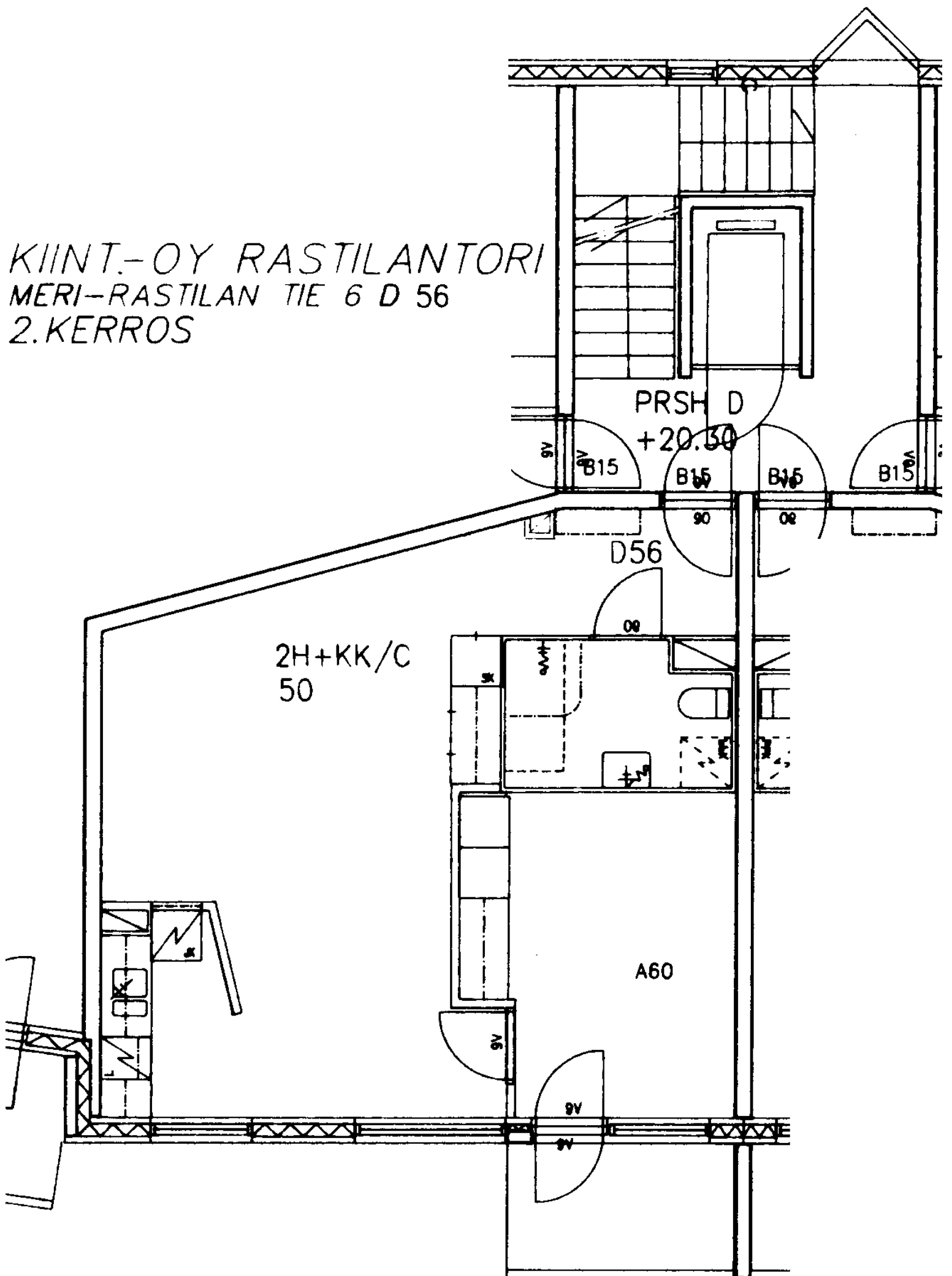

KIINT.-OY RASTILANTORI  
MERI-RASTILAN TIE 6 D 57  
2.KERROS

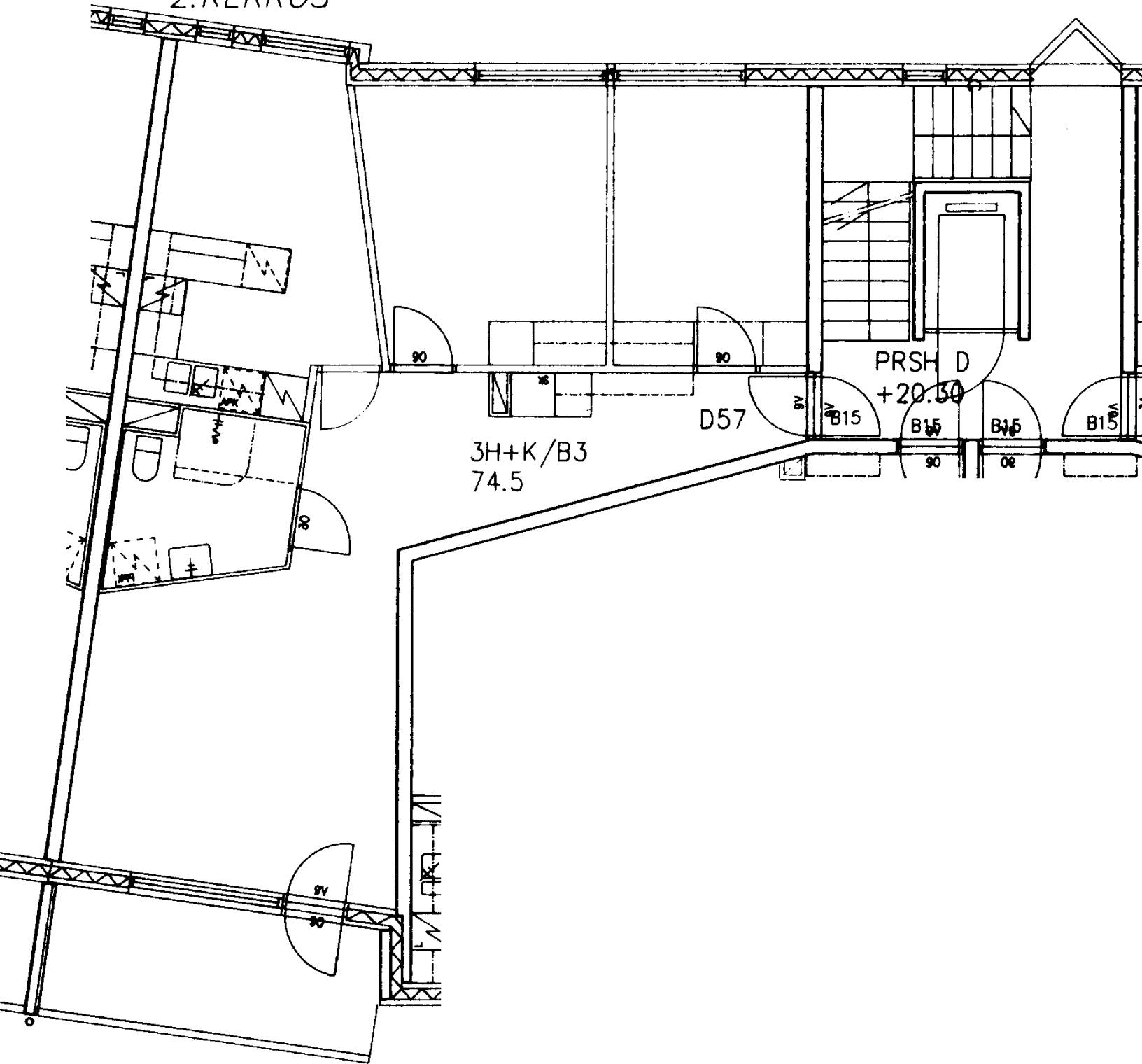

KIINT.-OY RASTILANTORI  
MERI-RASTILAN TIE 6 D 58  
3.KERROS

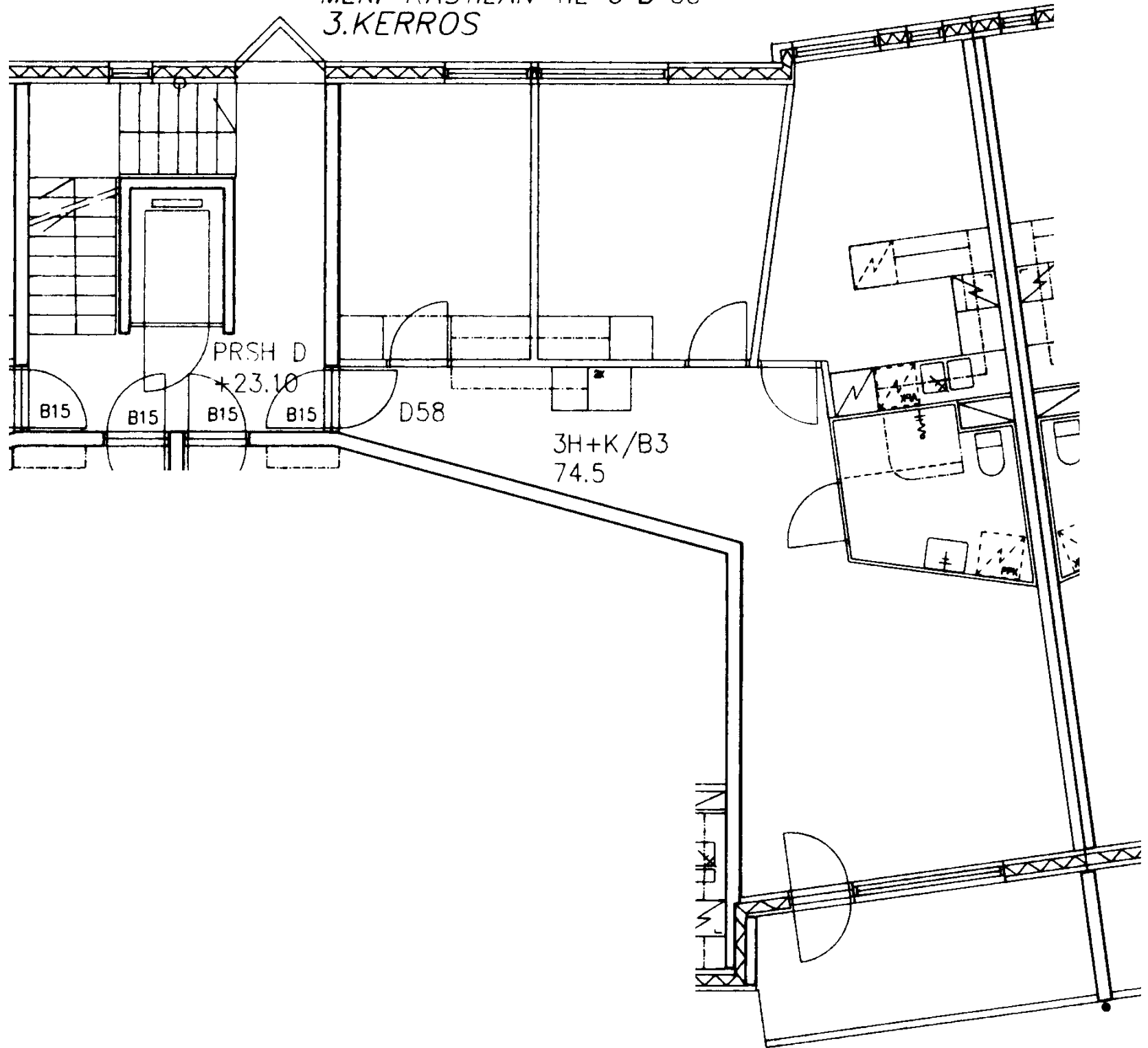

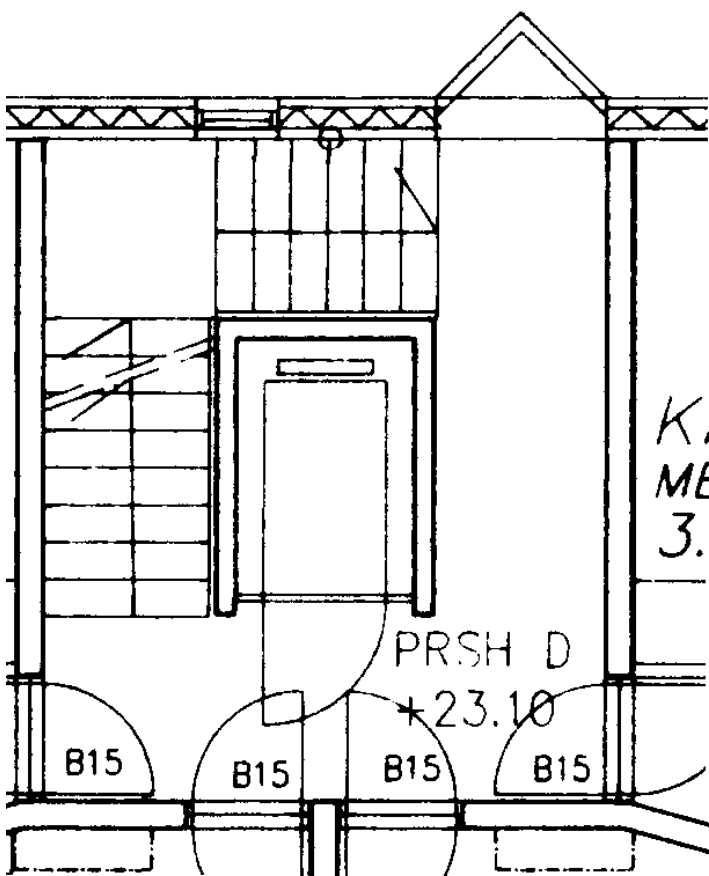

KIINT.-OY RASTILANTORI  
MERI-RASTILAN TIE 6 D 59  
3.KERROS

PRSH D  
+23.10

B15

B15

B15

B15

D59

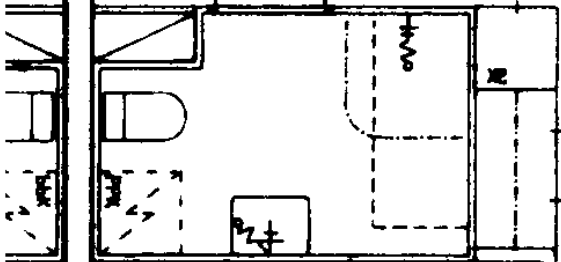

2H+KK/C  
50

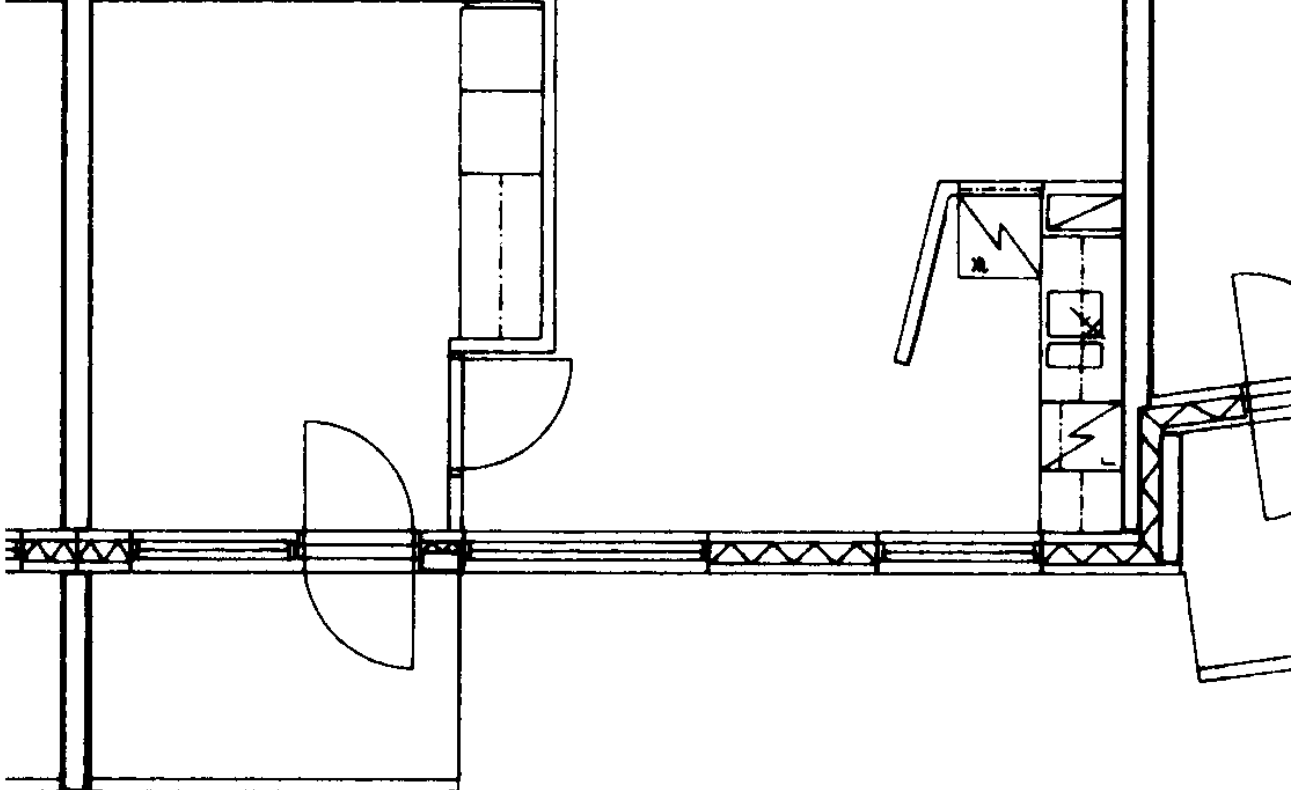

KIINT.-OY RASTILANTORI  
MERI-RASTILAN TIE 6 D 60  
3.KERROS

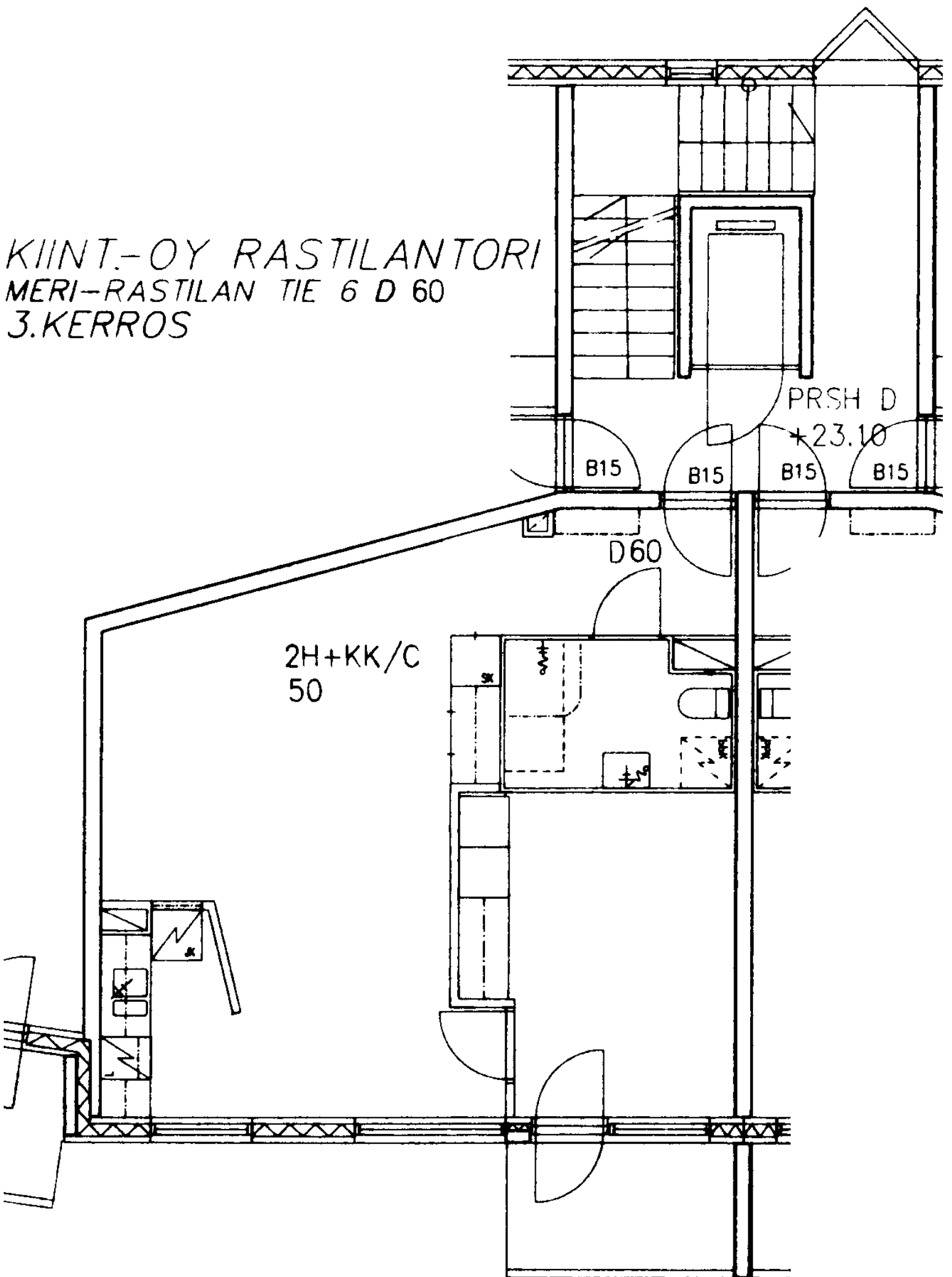

KIINT.-OY RASTILANTORI  
MERI-RASTILAN TIE 6 D 61  
3.KERROS

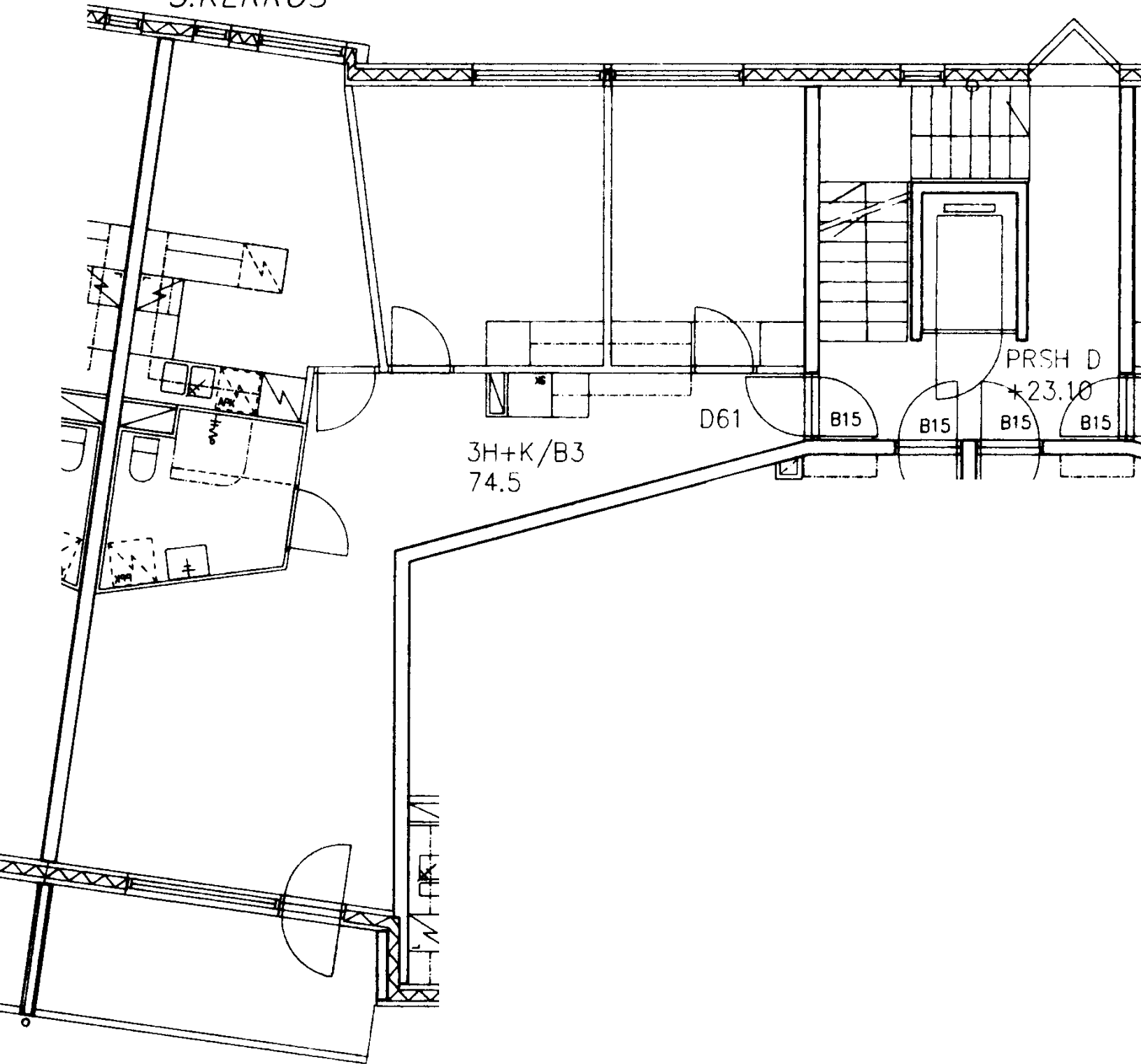

KIINT.-OY RASTILANTORI  
MERI-RASTILAN TIE 6 D 62  
4.KERROS

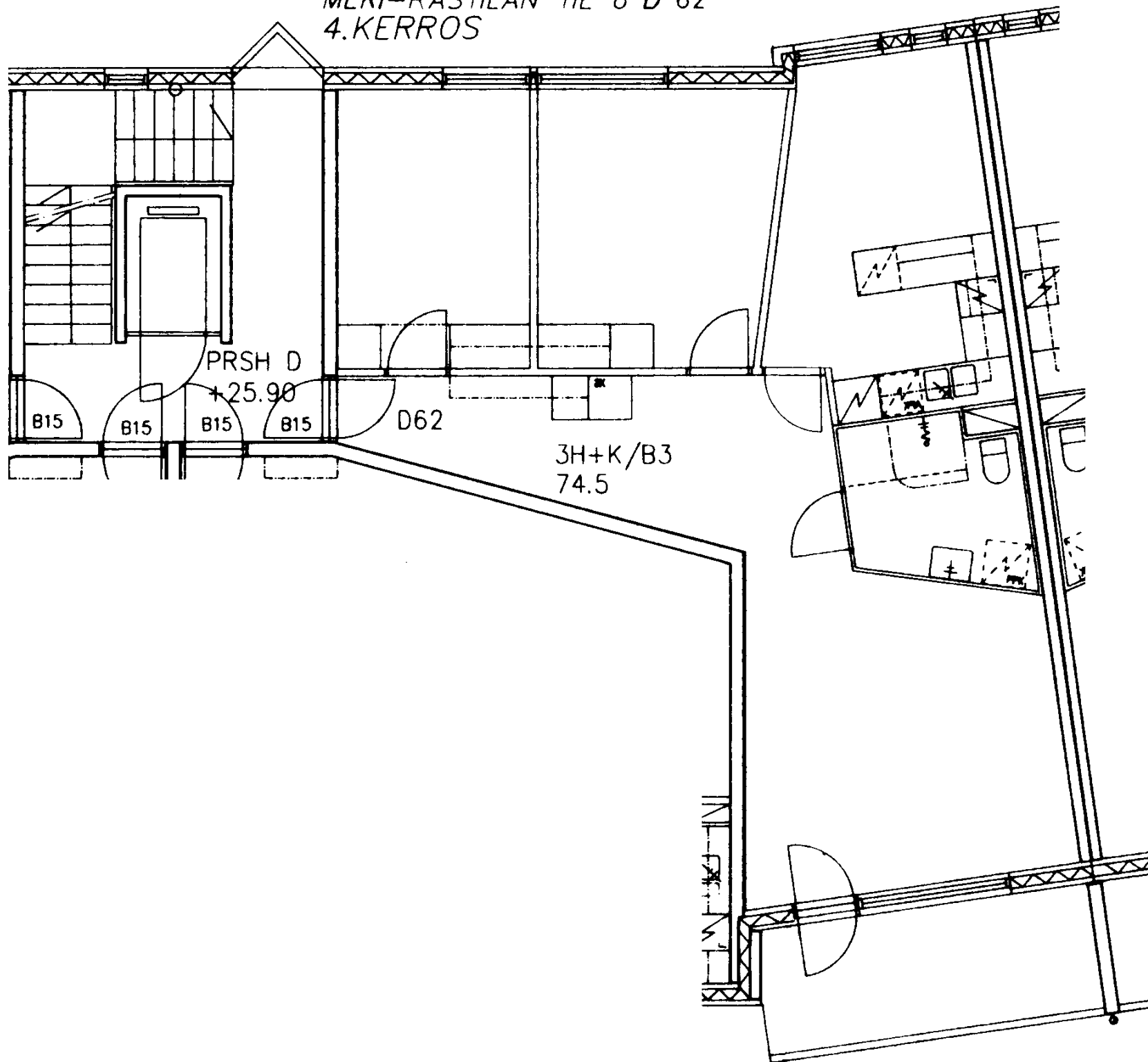

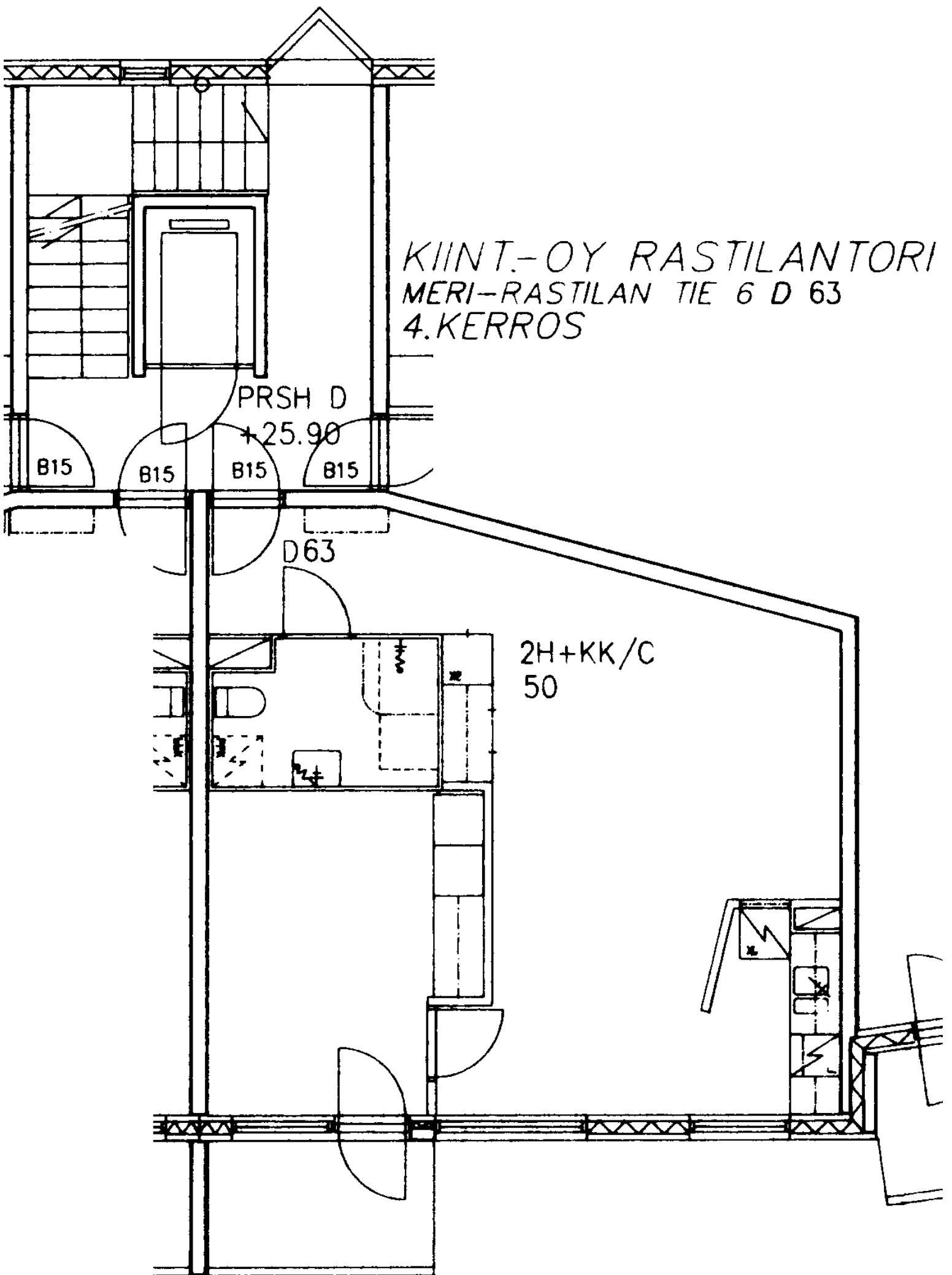

KIINT.-OY RASTILANTORI  
MERI-RASTILAN TIE 6 D 64  
4.KERROS

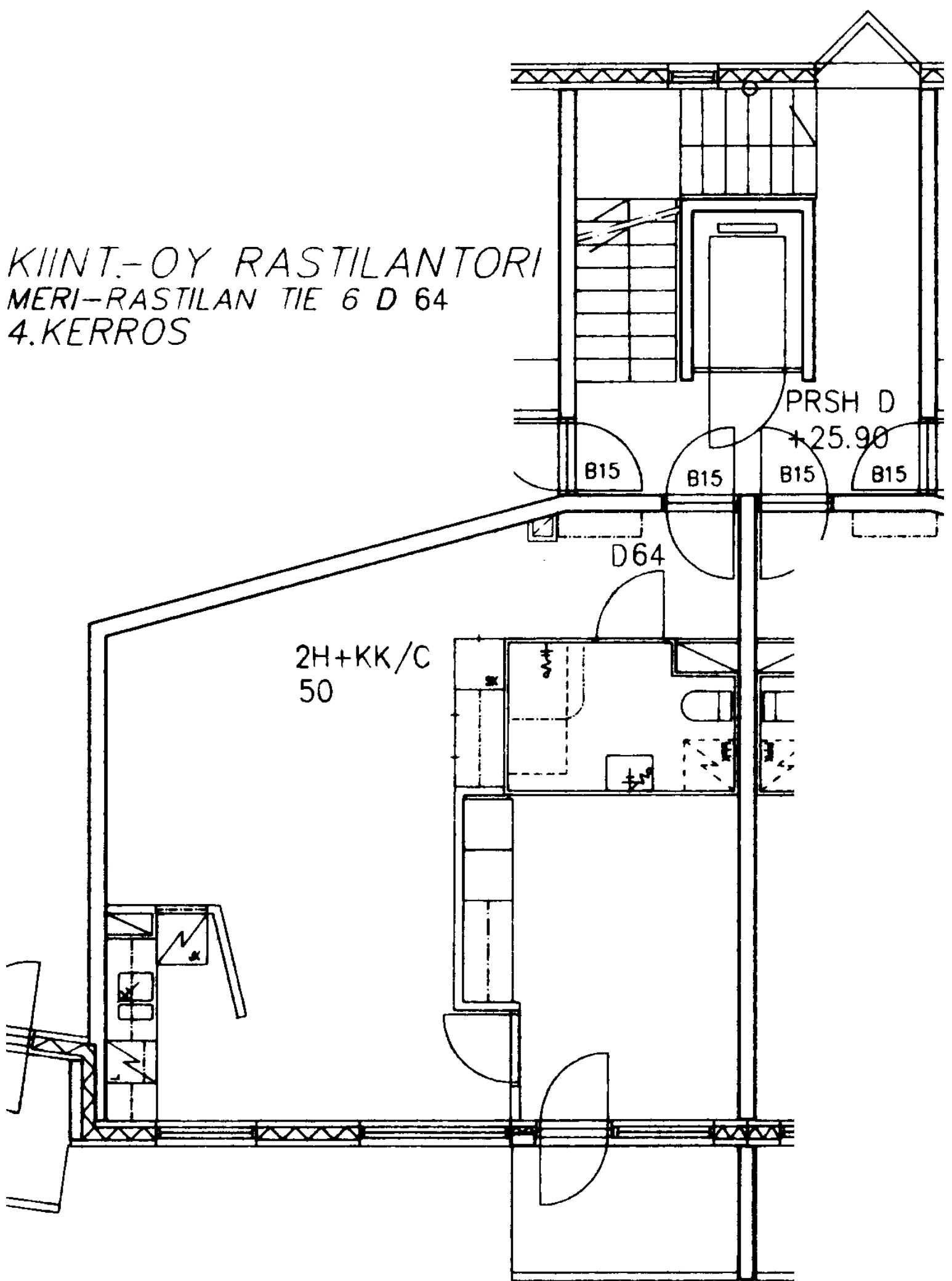

KIINT.-OY RASTILANTORI  
MERI-RASTILAN TIE 6 D 65  
4.KERROS

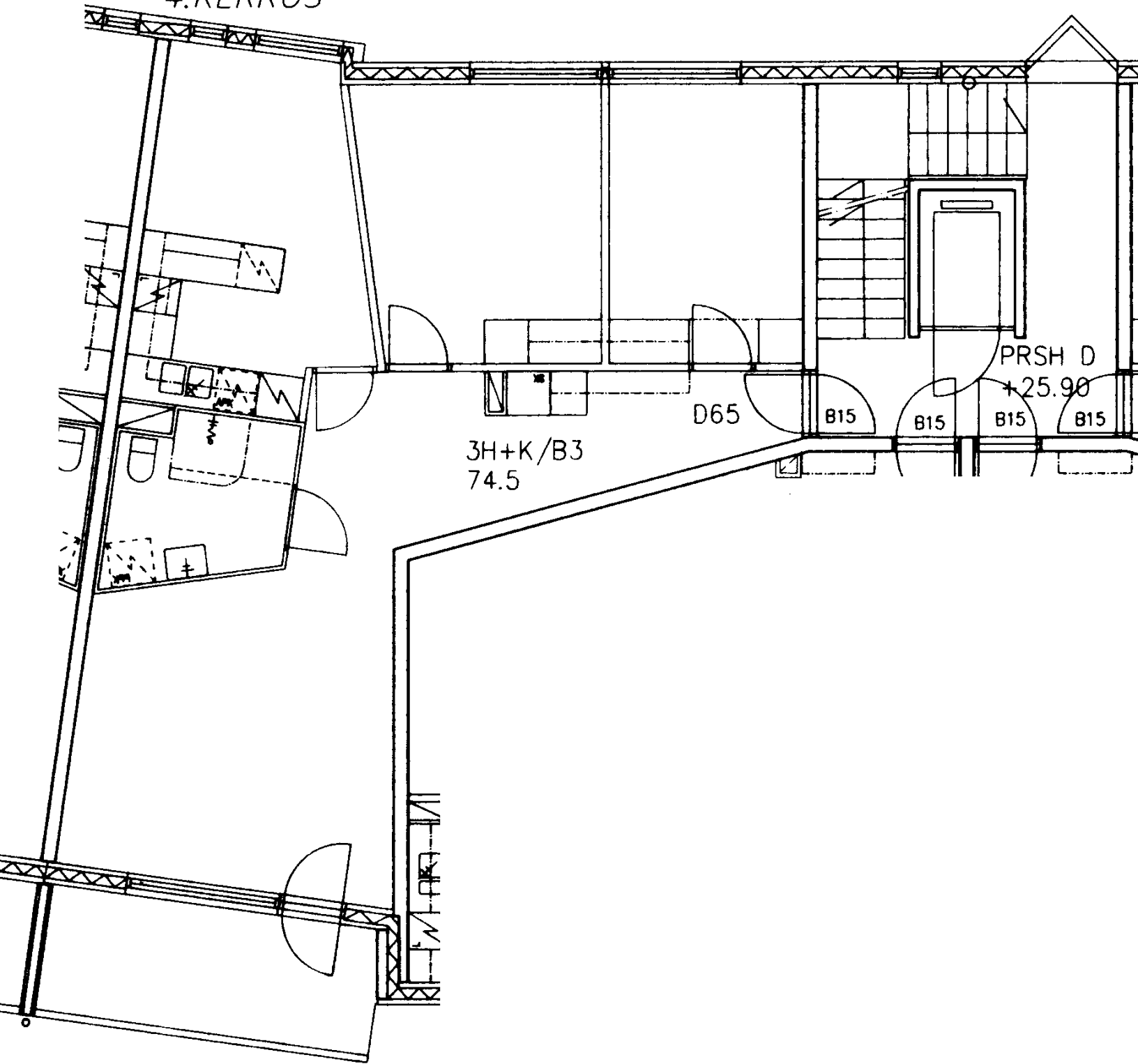

KIINT.-OY RASTILANTORI  
MERI-RASTILAN TIE 6 D 66  
5.KERROS

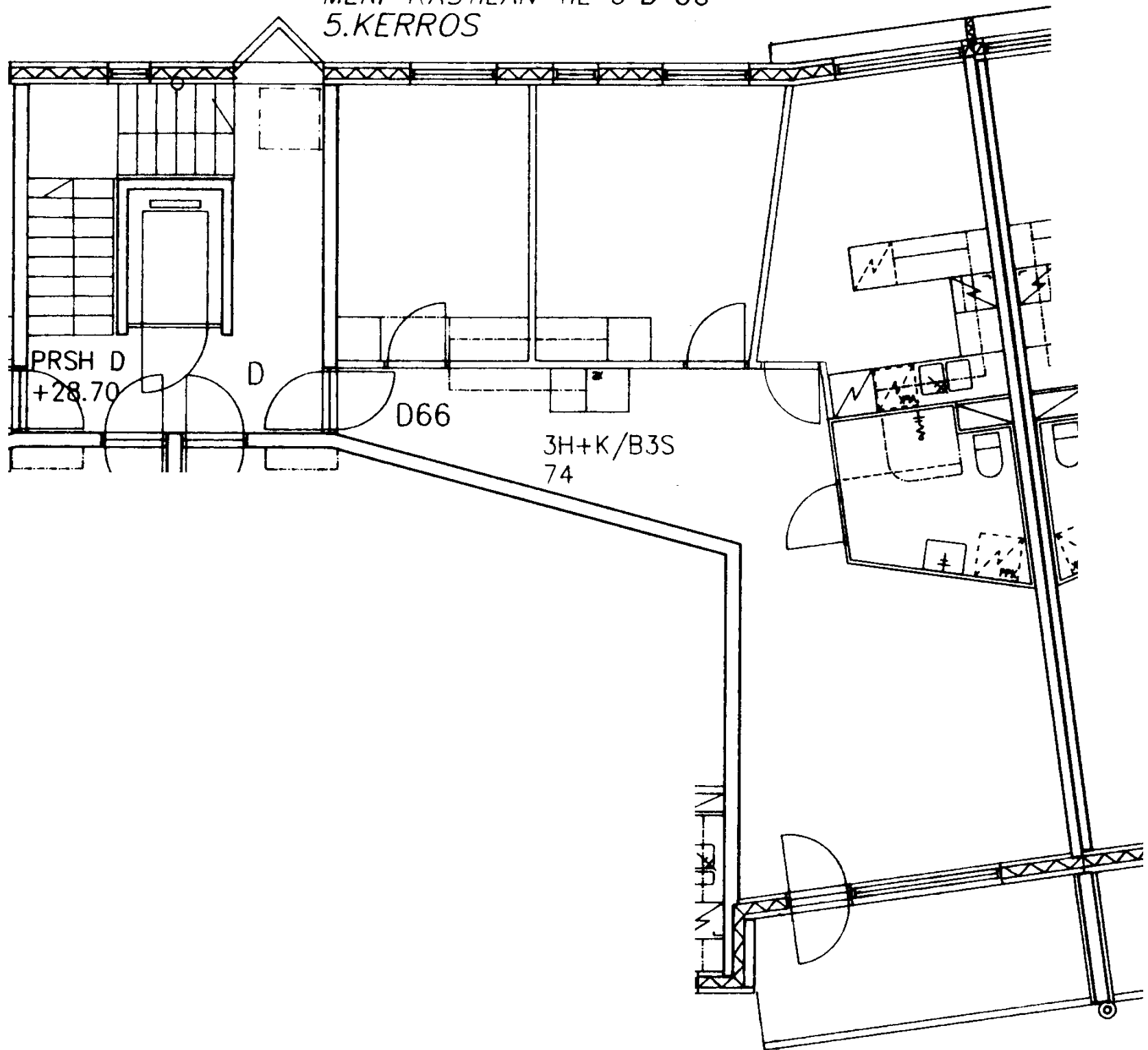

PRSH D  
+28.70

D

D66

3H+K/B3S  
74

W  
U  
S  
I  
N

KIINT.-OY RASTILANTORI  
MERI-RASTILAN TIE 6 D 52  
1.KERROS

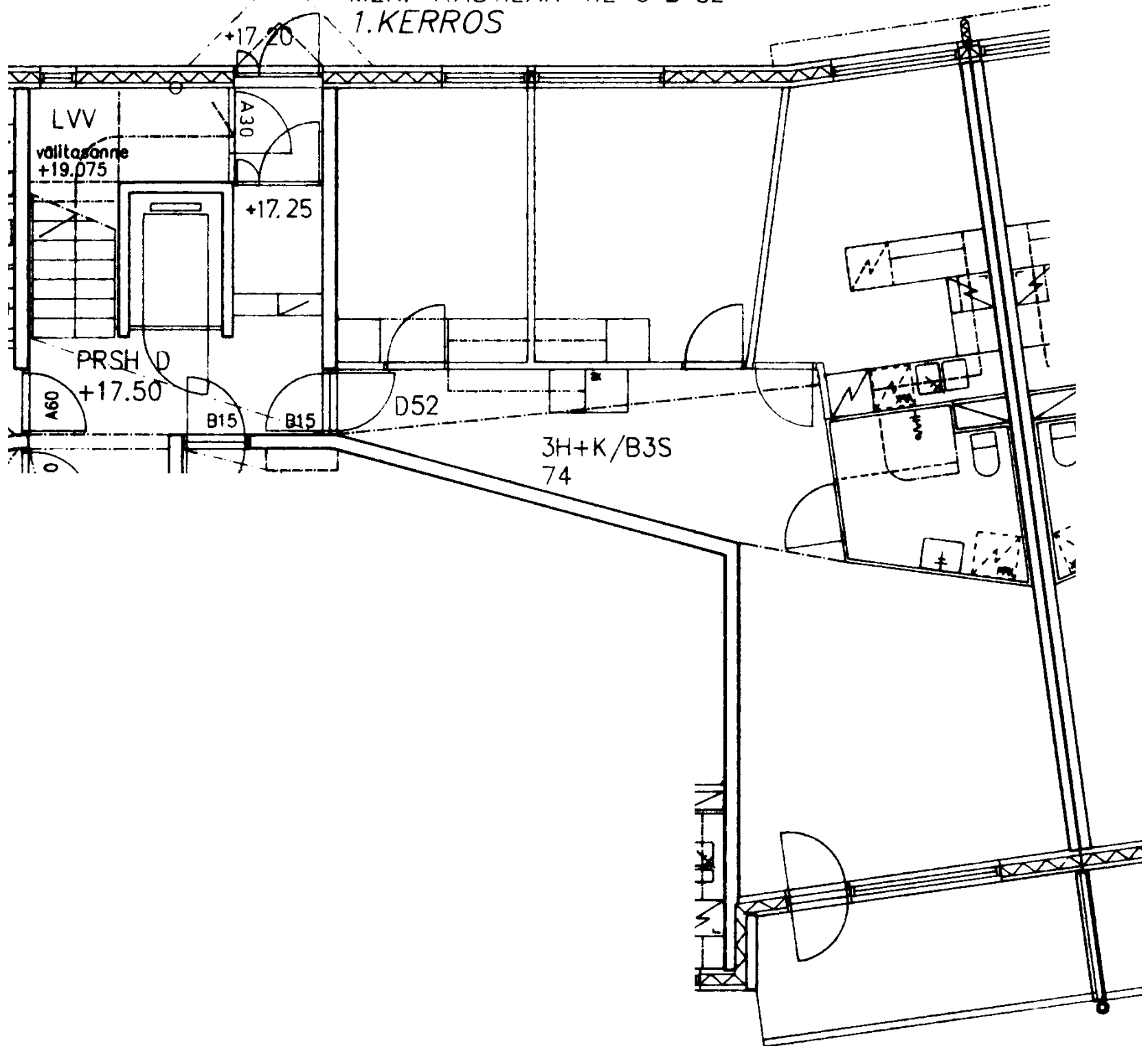

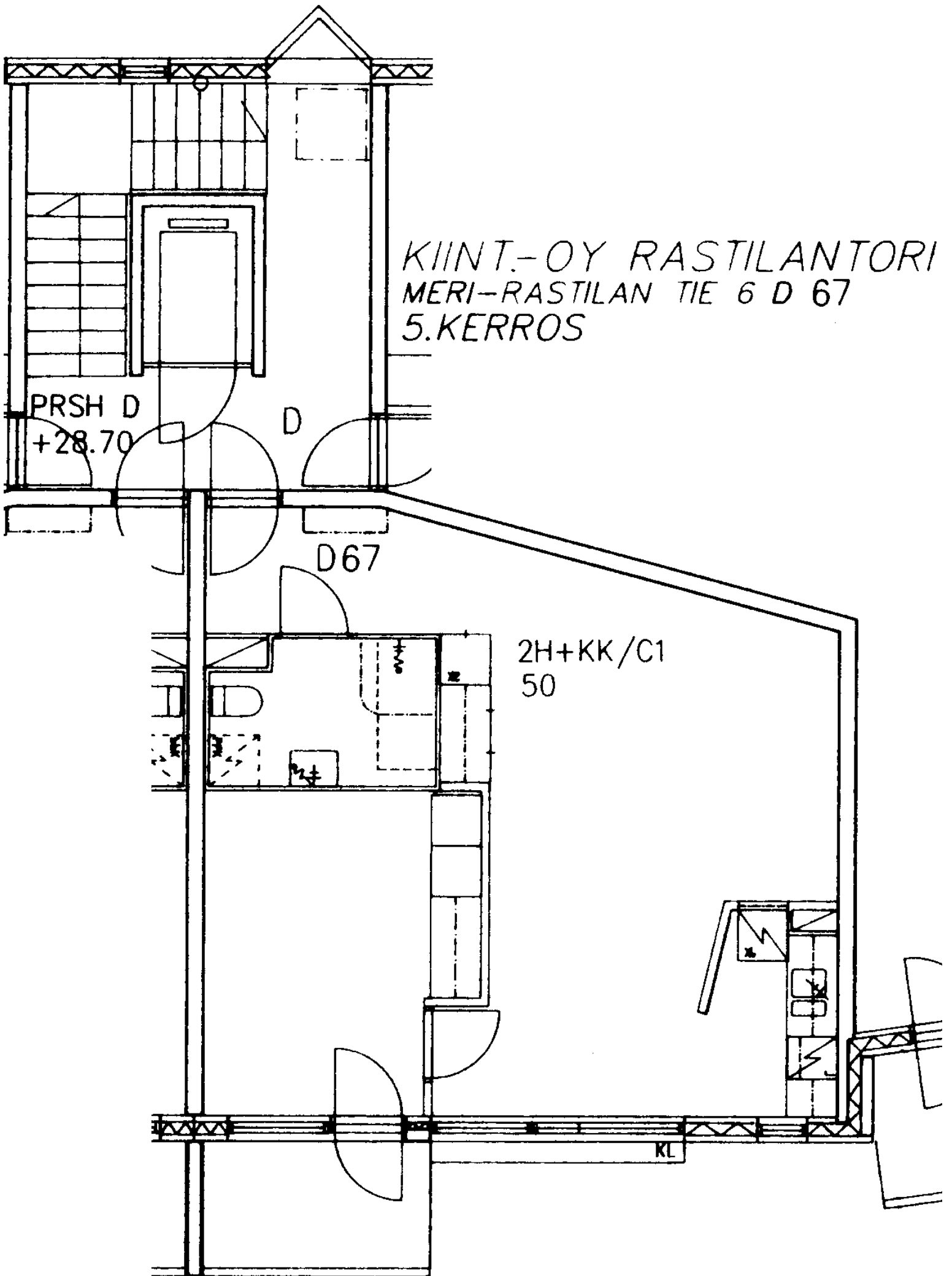

KIINT.-OY RASTILANTORI  
MERI-RASTILAN TIE 6 D 68  
5.KERROS

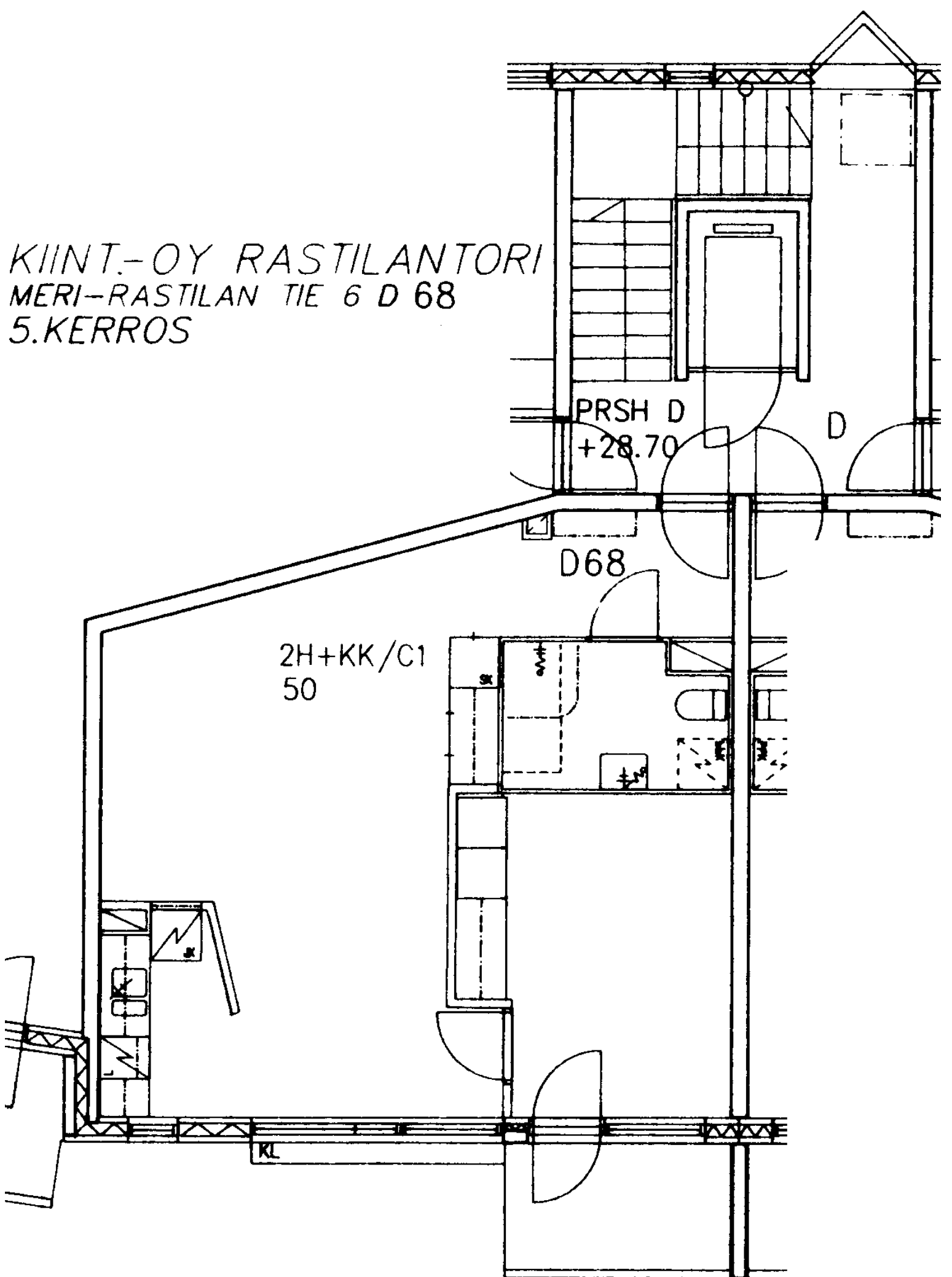

KIINT.-OY RASTILANTORI  
MERI-RASTILAN TIE 6 D 69  
5.KERROS

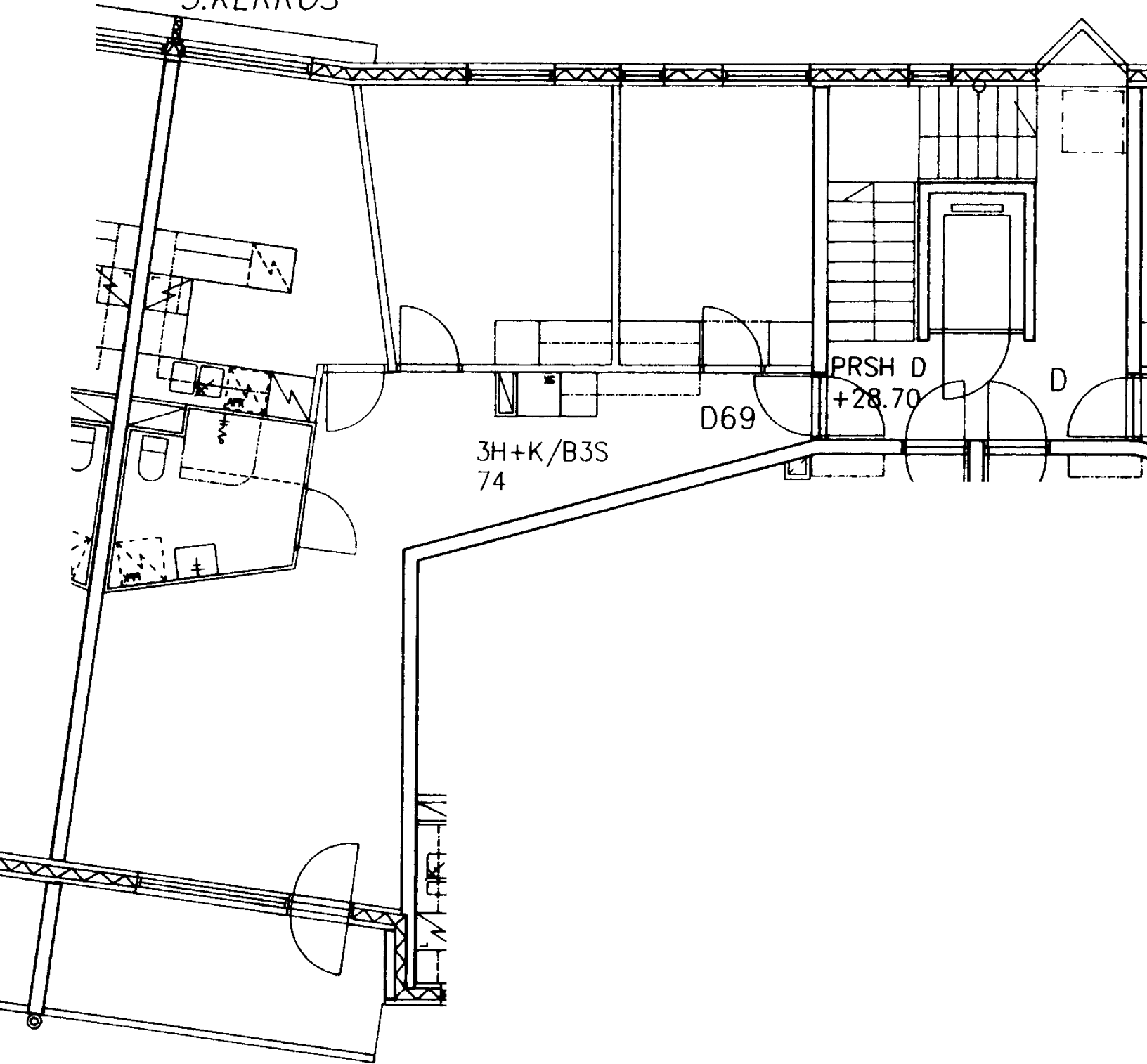

KIINT.-OY RASTILANTORI  
MERI-RASTILAN TIE 6 D 53  
1.KERROS

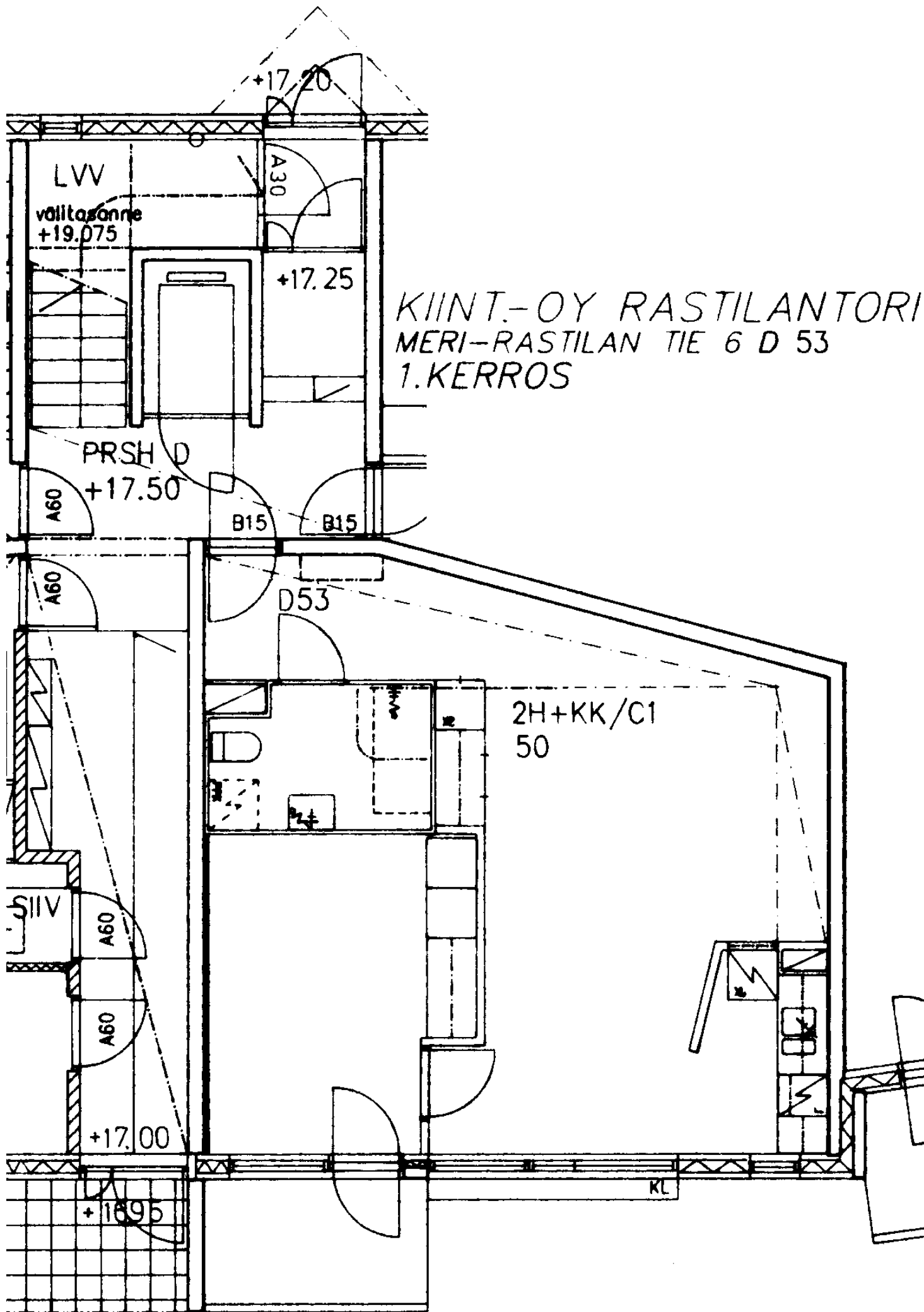

LVV

välitasanne  
+19.075

A30

+17.25

PRSH D  
+17.50

A60

B15

B15

A60

D53

2H+KK/C1  
50

SIV

A60

A60

+17.00

+16.95

KL

KIINT.-OY RASTILANTORI  
MERI-RASTILAN TIE 6 D 54  
2.KERROS

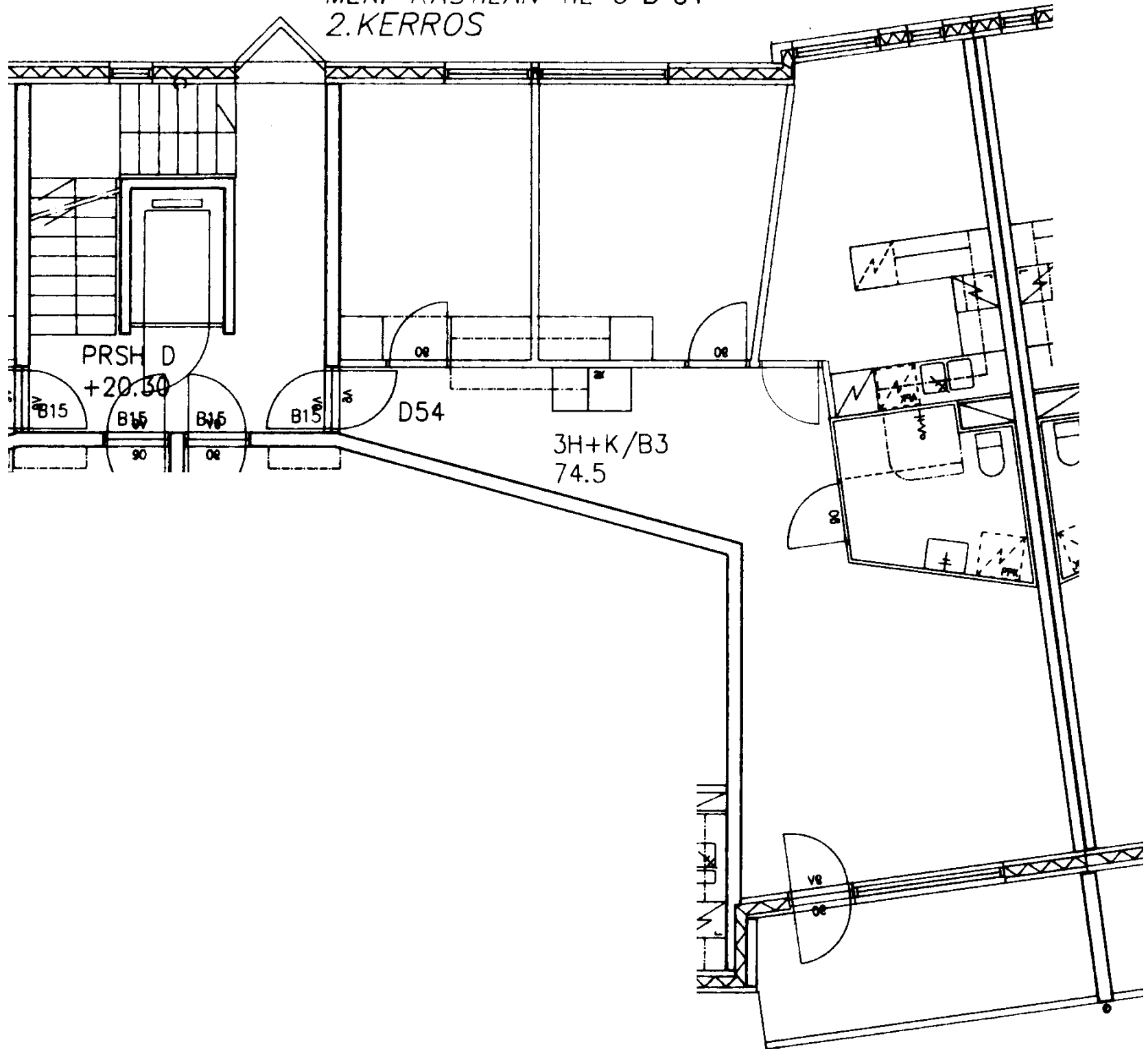

KIINT.-OY RASTILANTORI  
MERI-RASTILAN TIE 6 D 55  
2.KERROS

