

LPOB'S

K

TK

KPH

ET

SK

VH

MH

OH

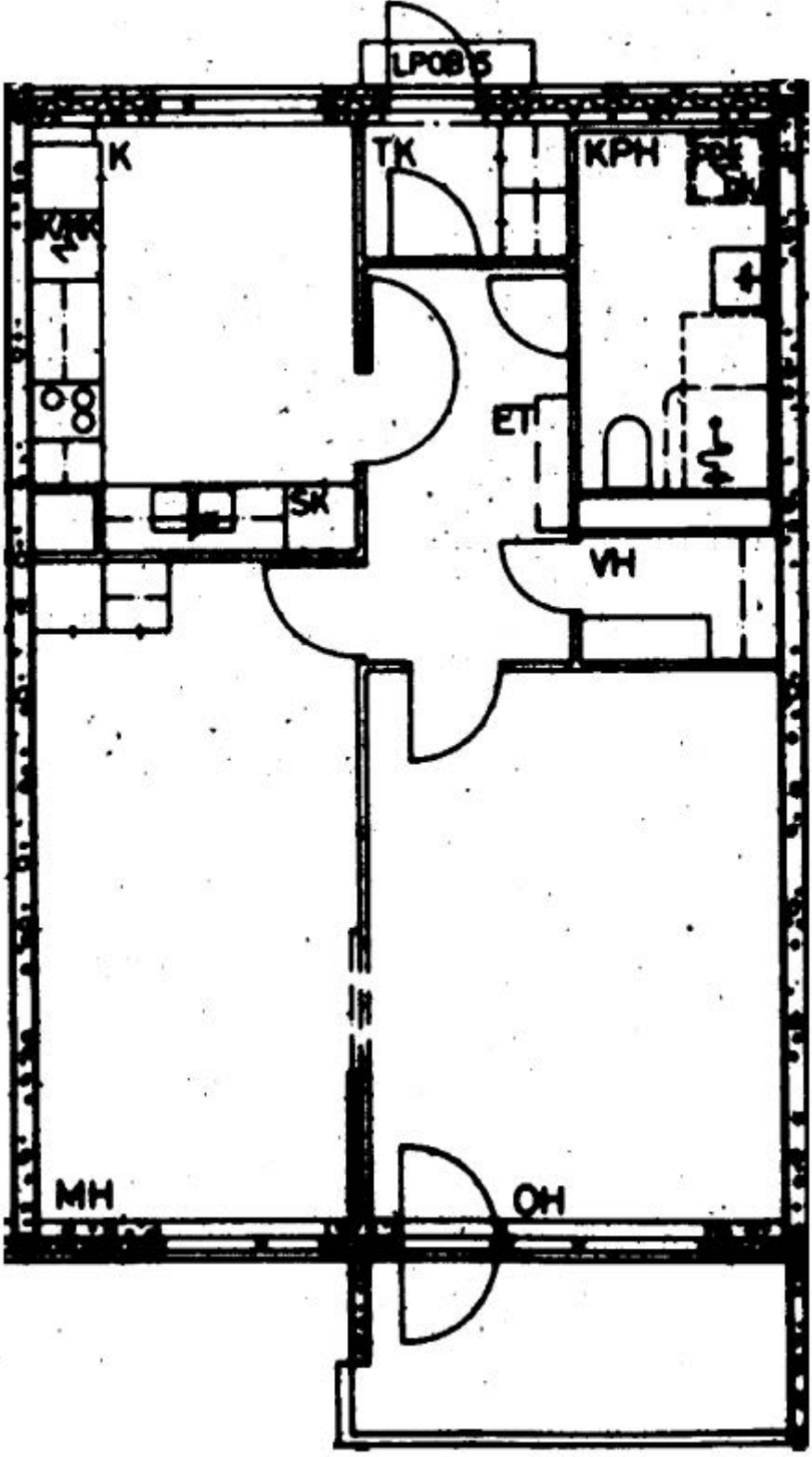

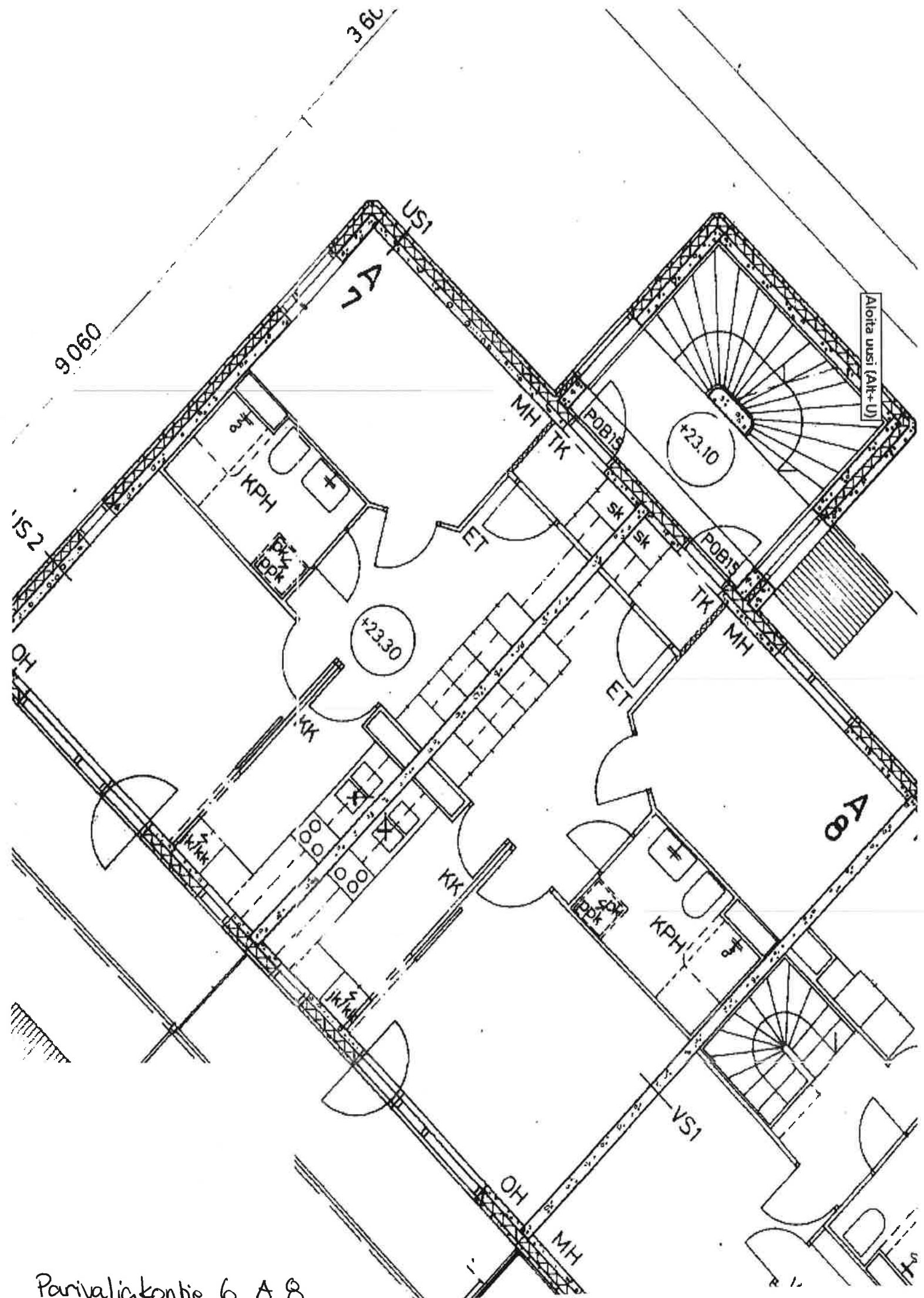

Parivaljakontie 6 A 8

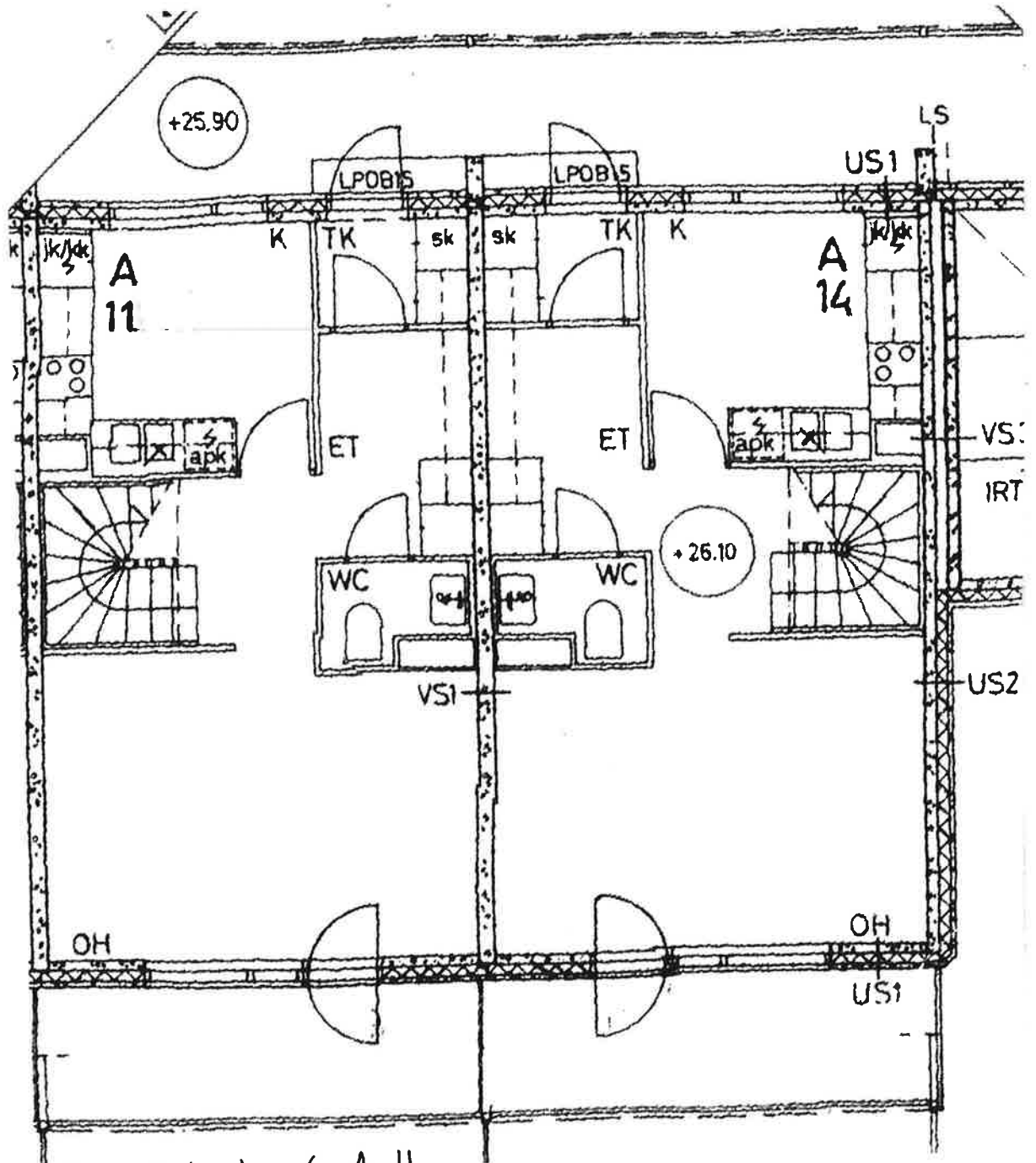

Parivaljakontie 6 A 11

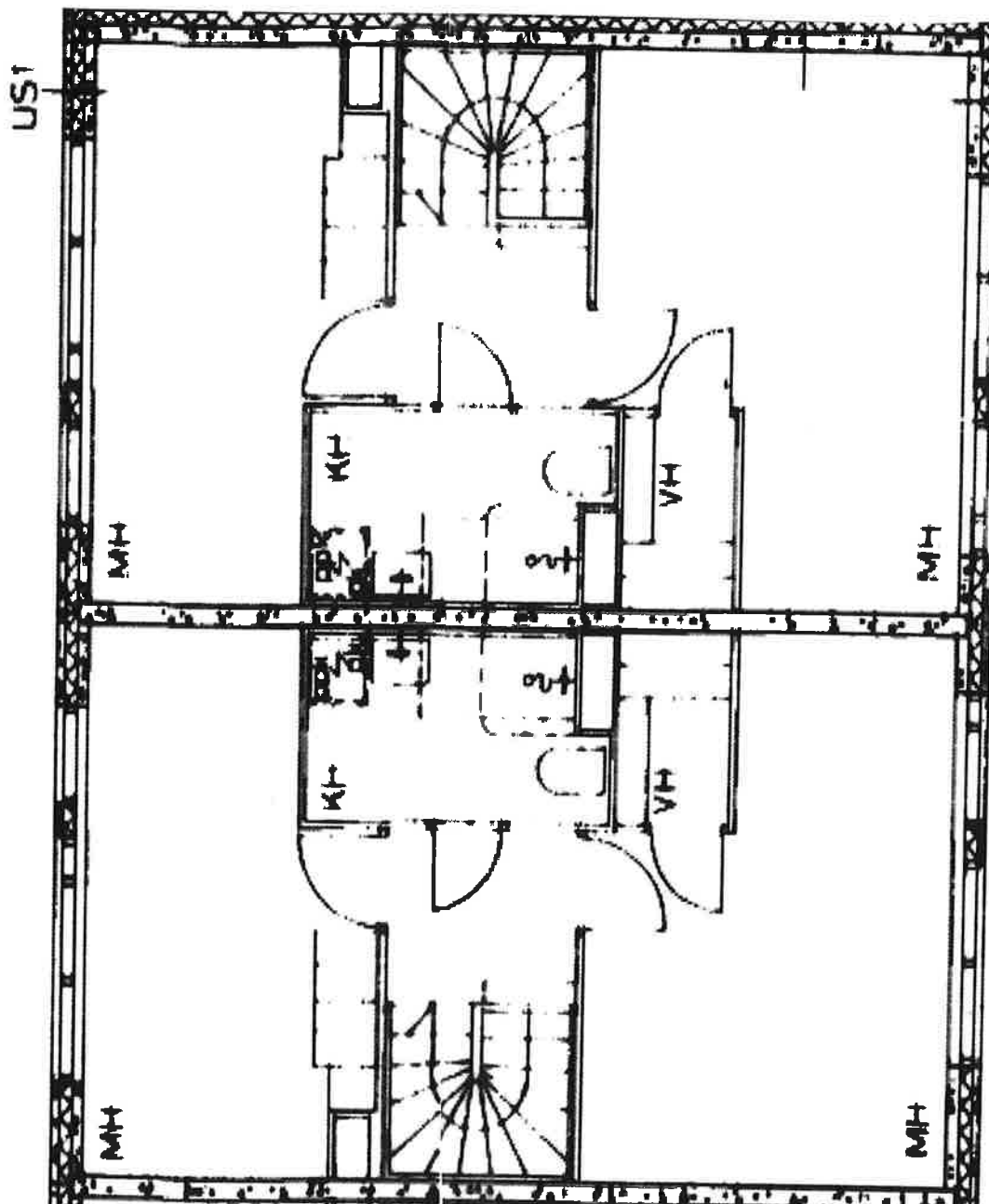

Parivallikontie 6 A II  
 9 krs.

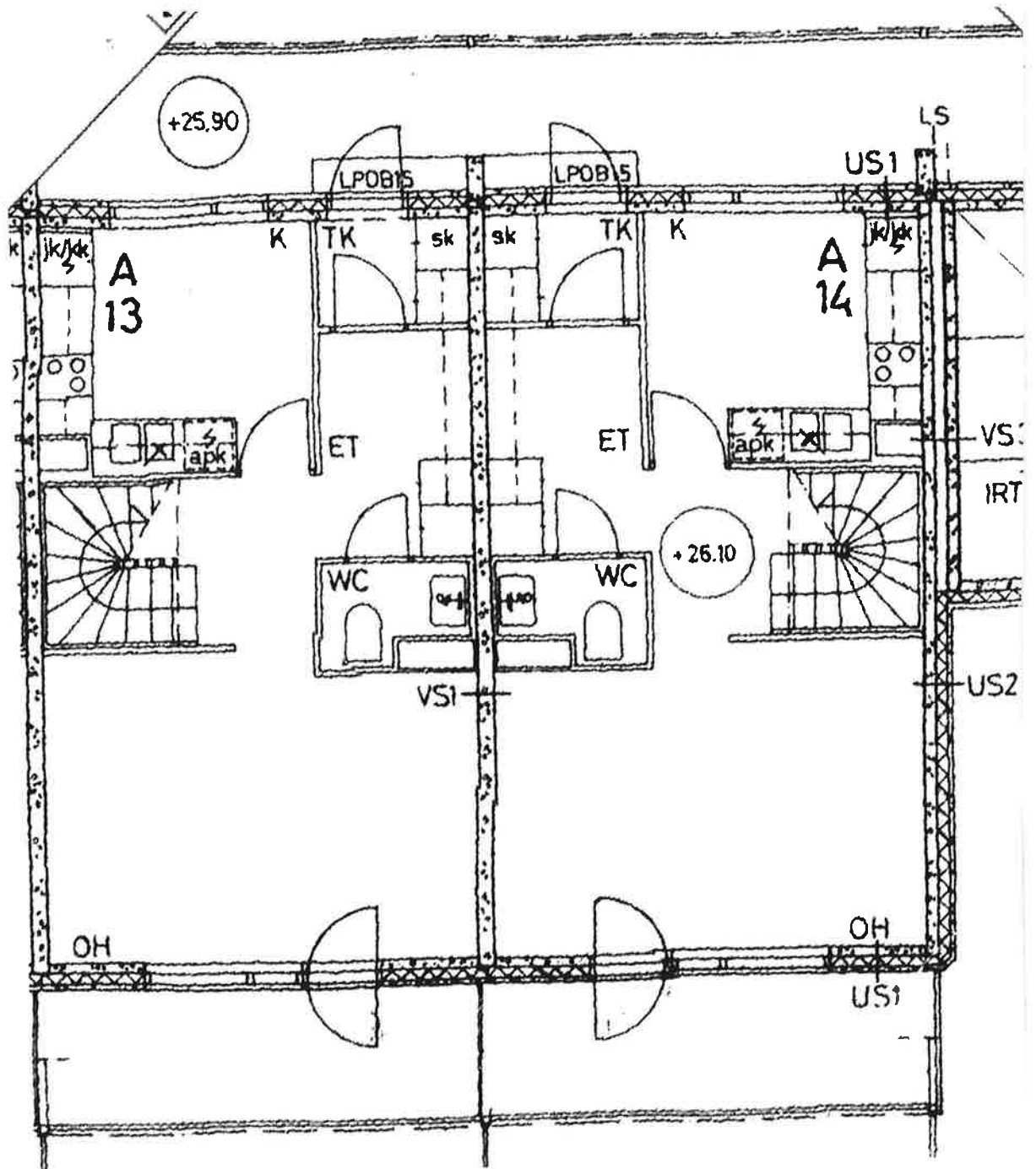

Parivaljakontie 6 A 13 JA 14

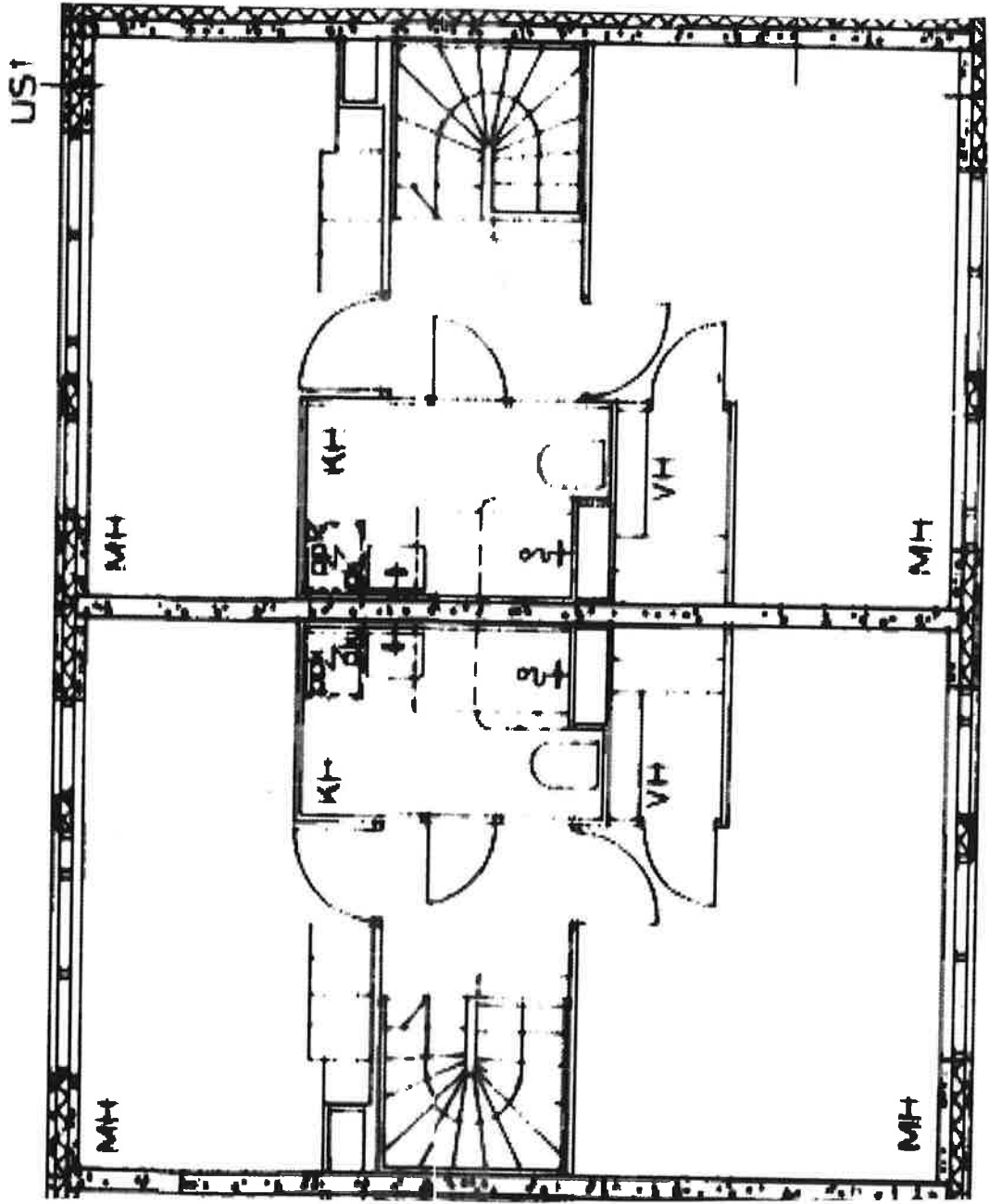

Parivalikantie 6 A 13 JA 14 2.kerros

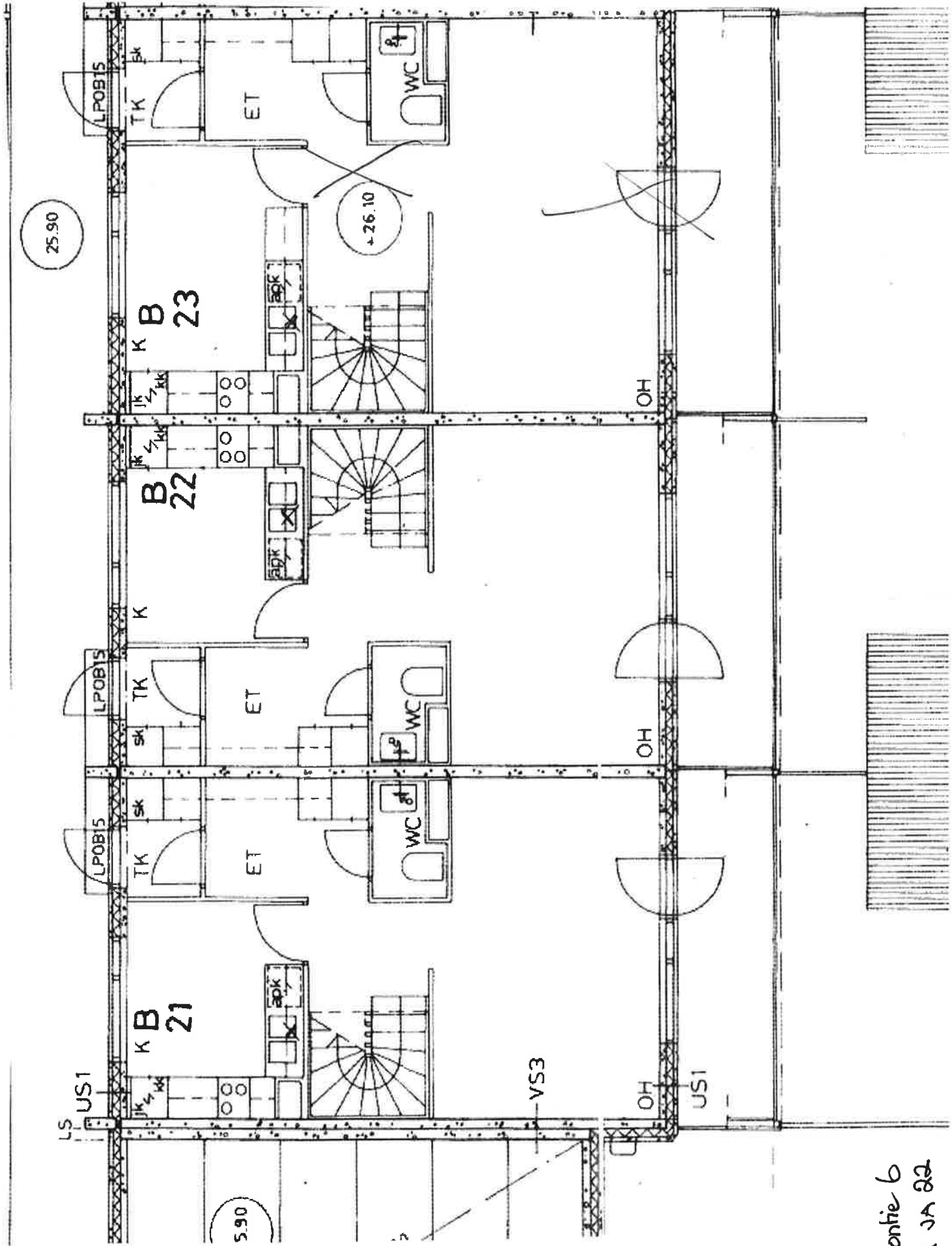

Parivaljakontie 6  
B 21 JA 22

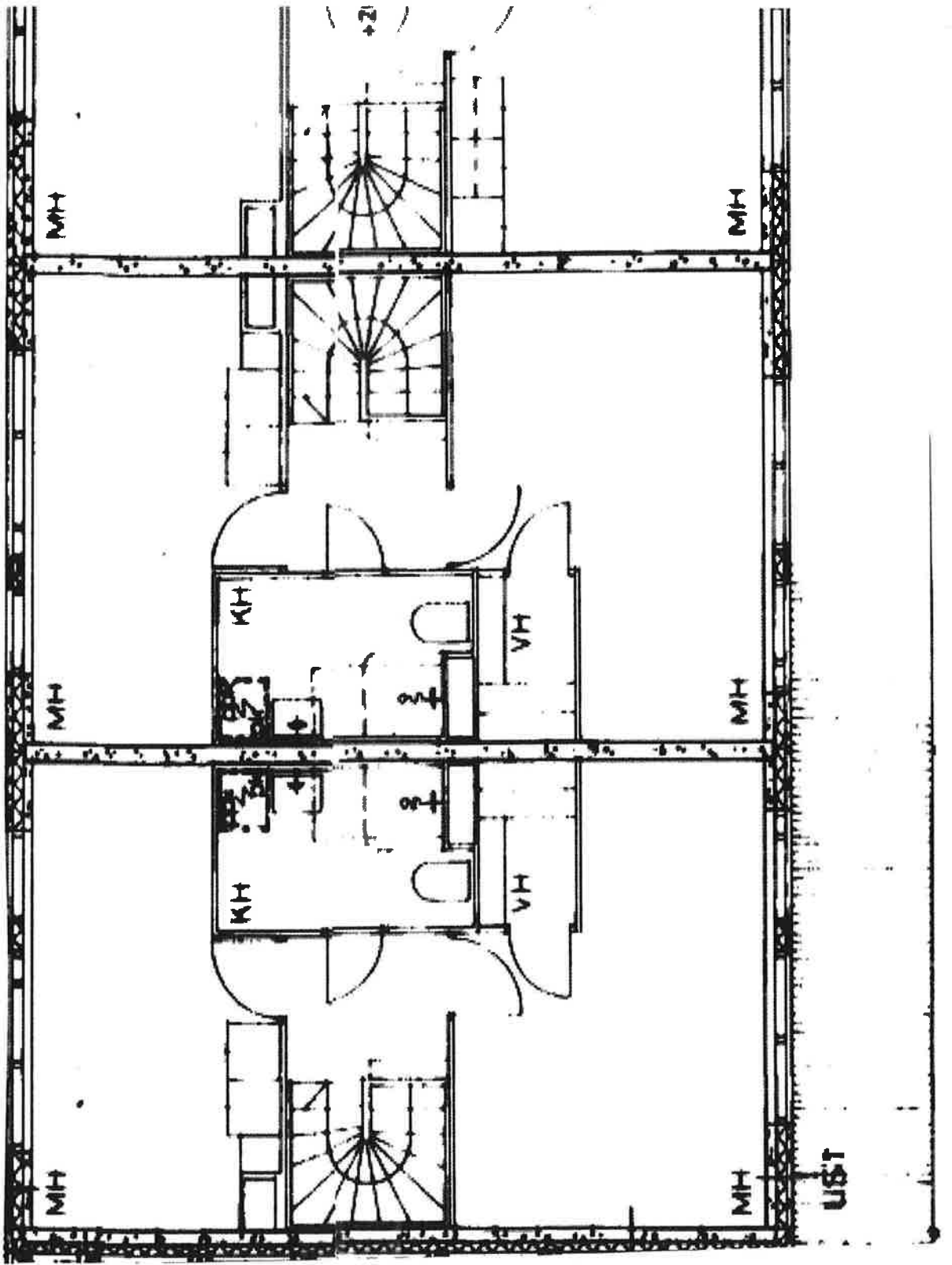

Parivaljakonte b B 21 ja 22

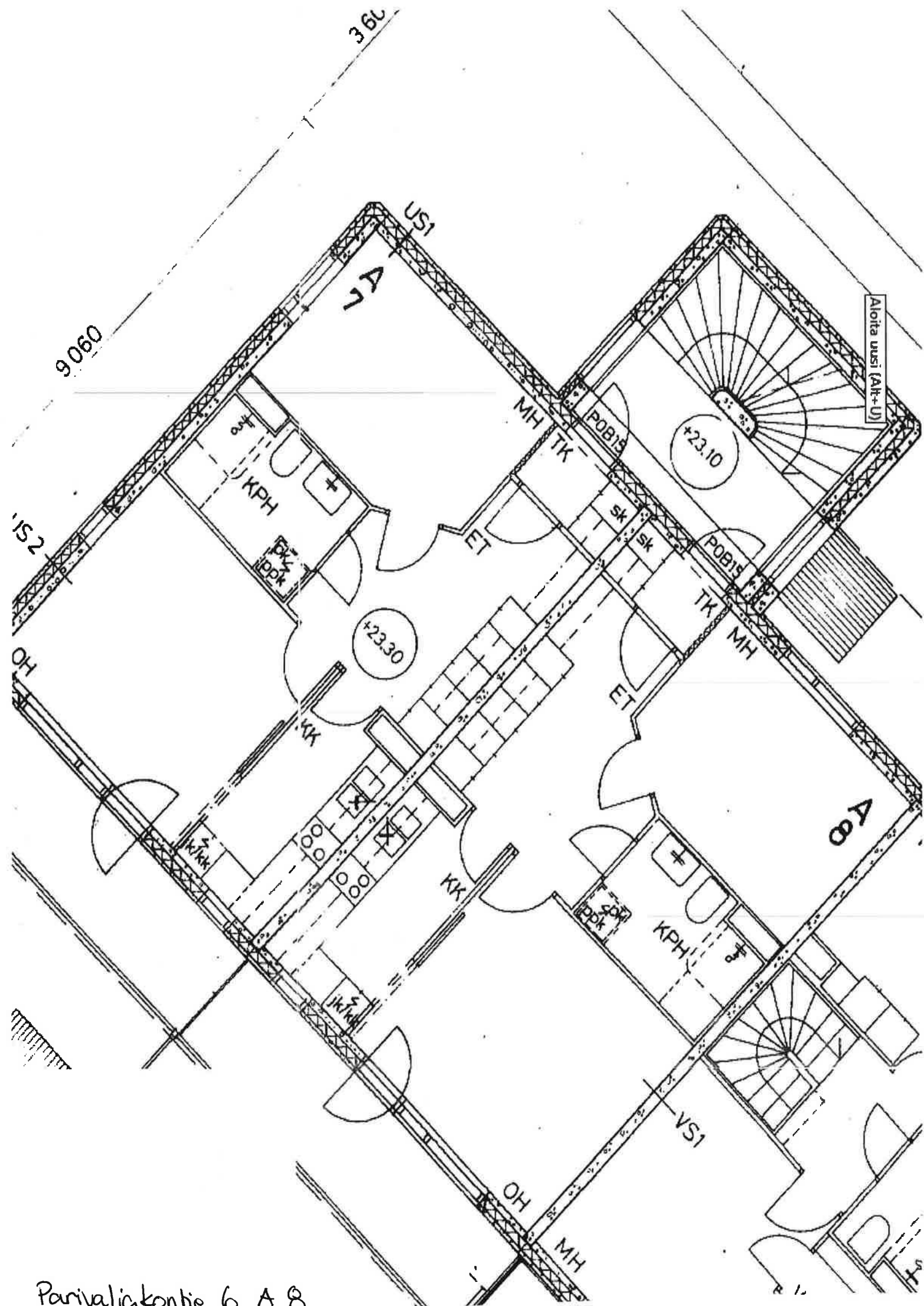

Parivaljakontie 6 A 8

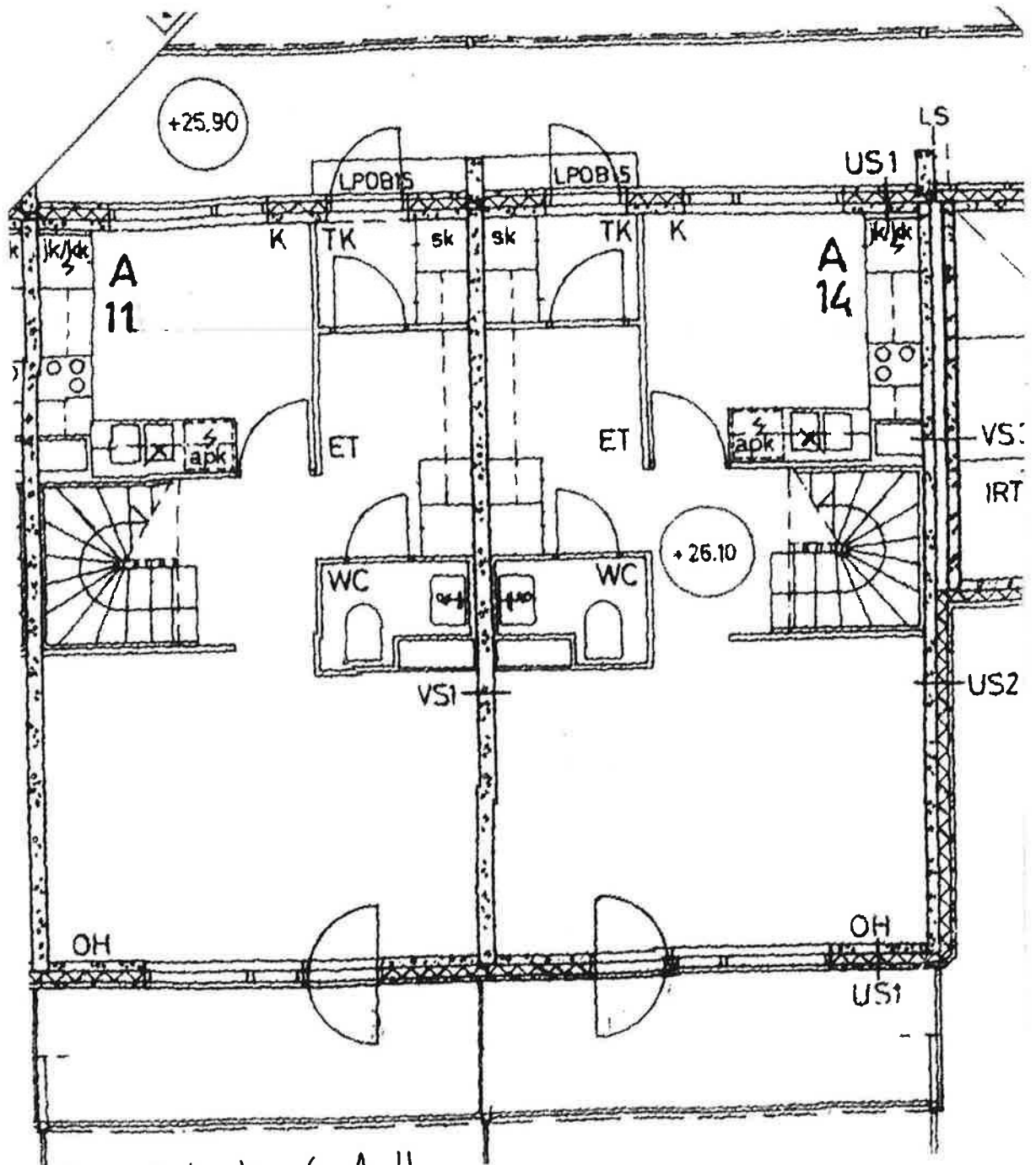

Parivaljakontie 6 A 11

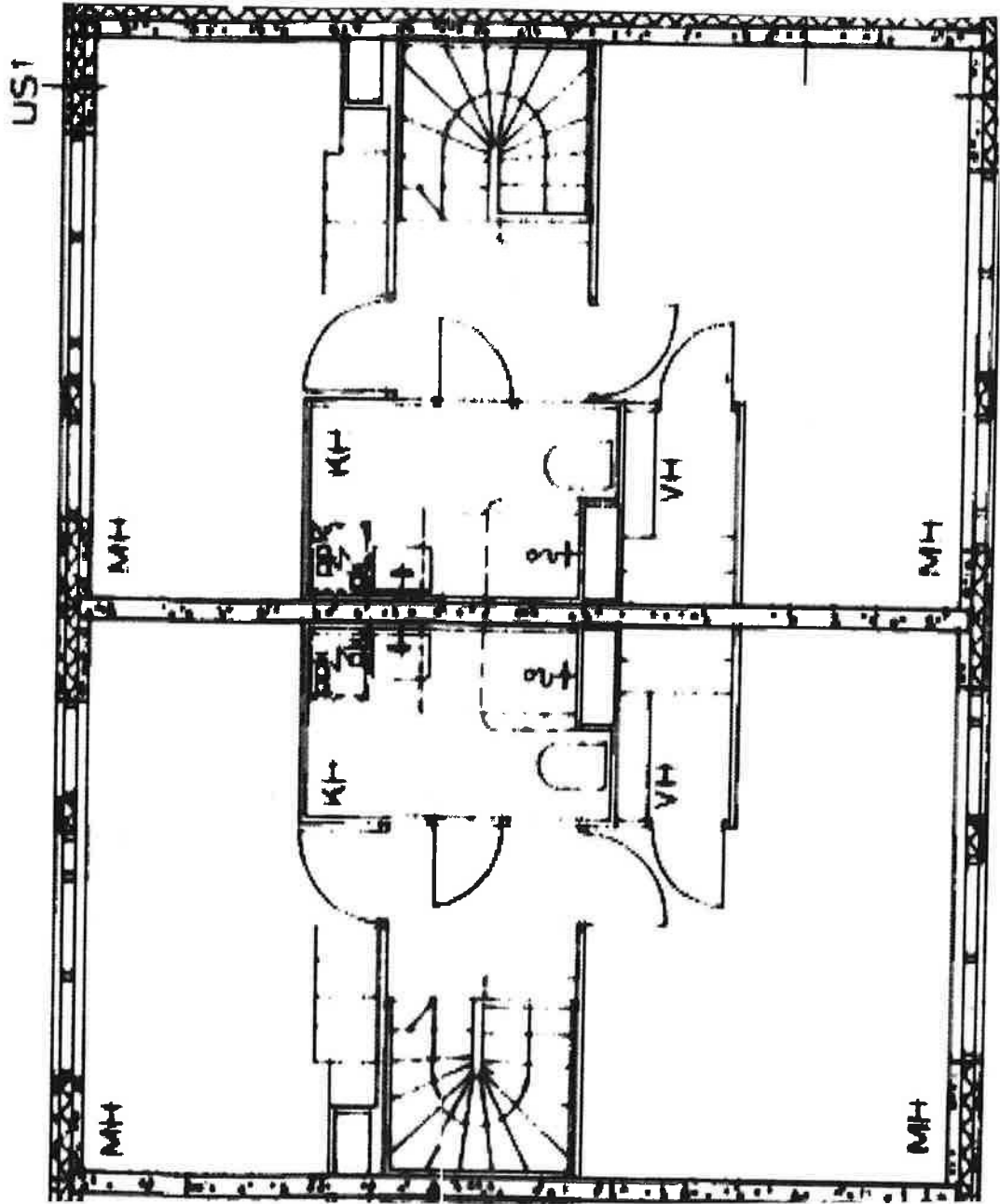

Parivallikontie 6 A II  
9 krs.

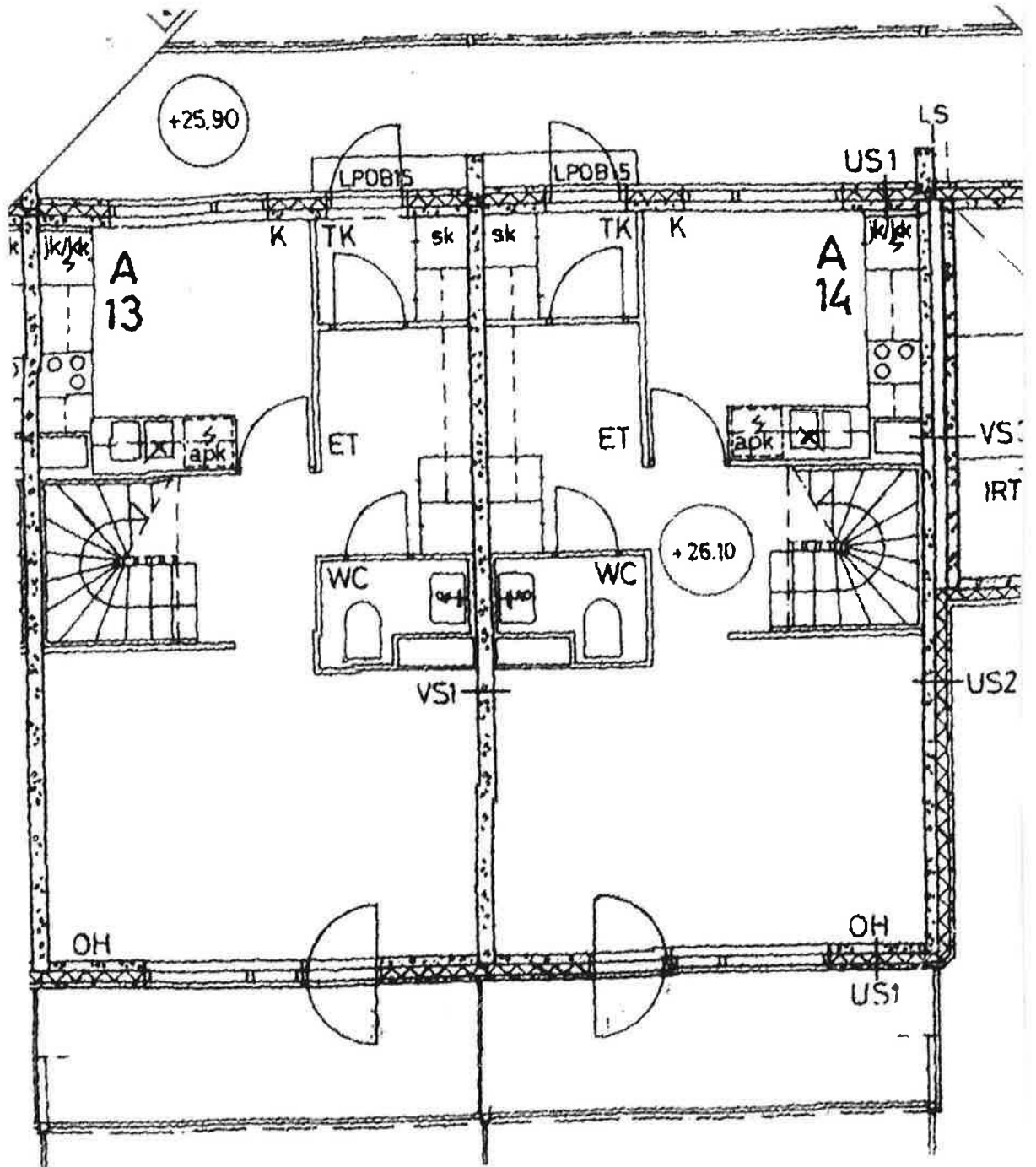

Parivaljakontie 6 A 13 JA 14

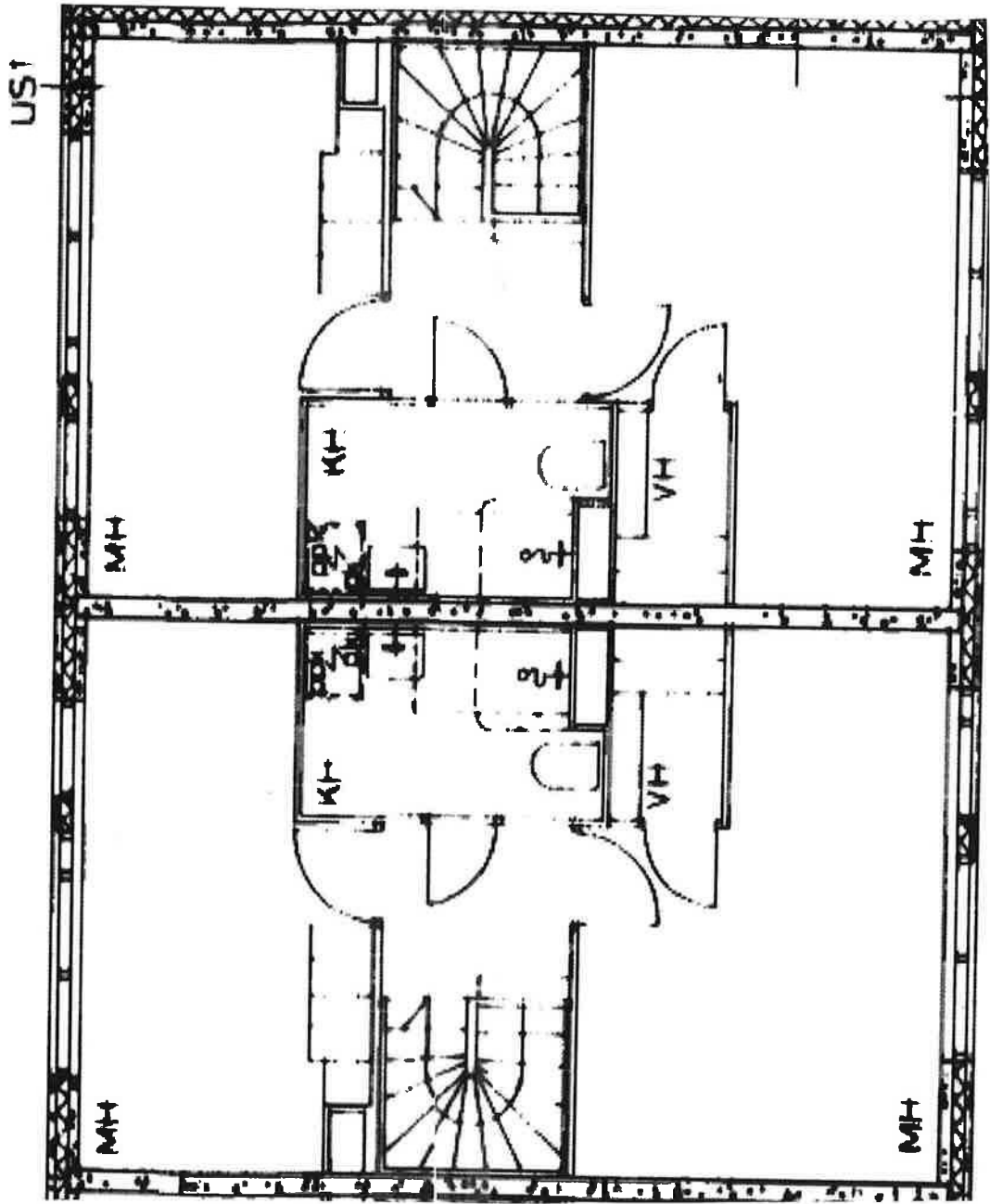

Parivalokantie 6 A 13 JA 14 2:kerros

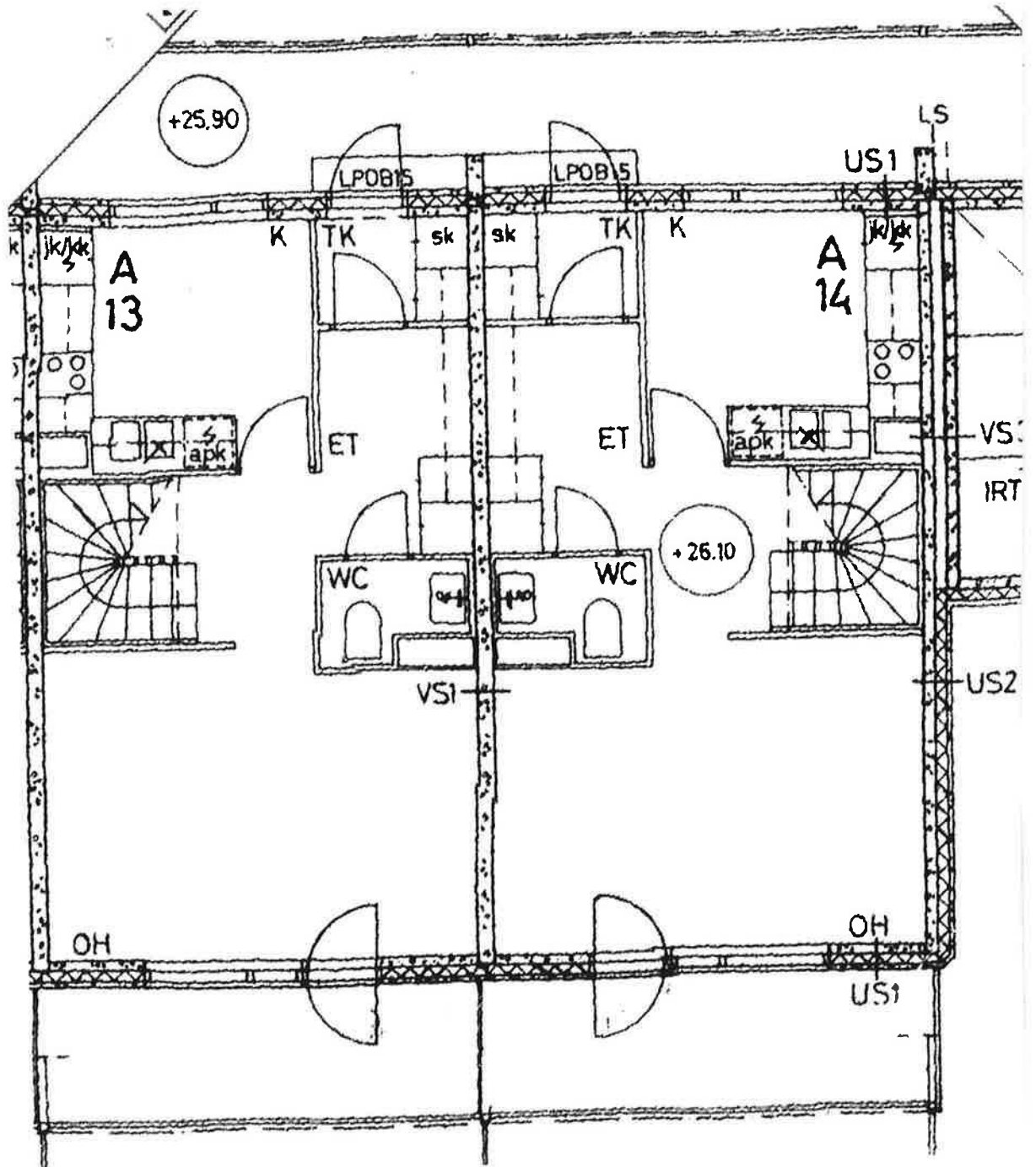

Parivaljakontie 6 A 13 JA 14

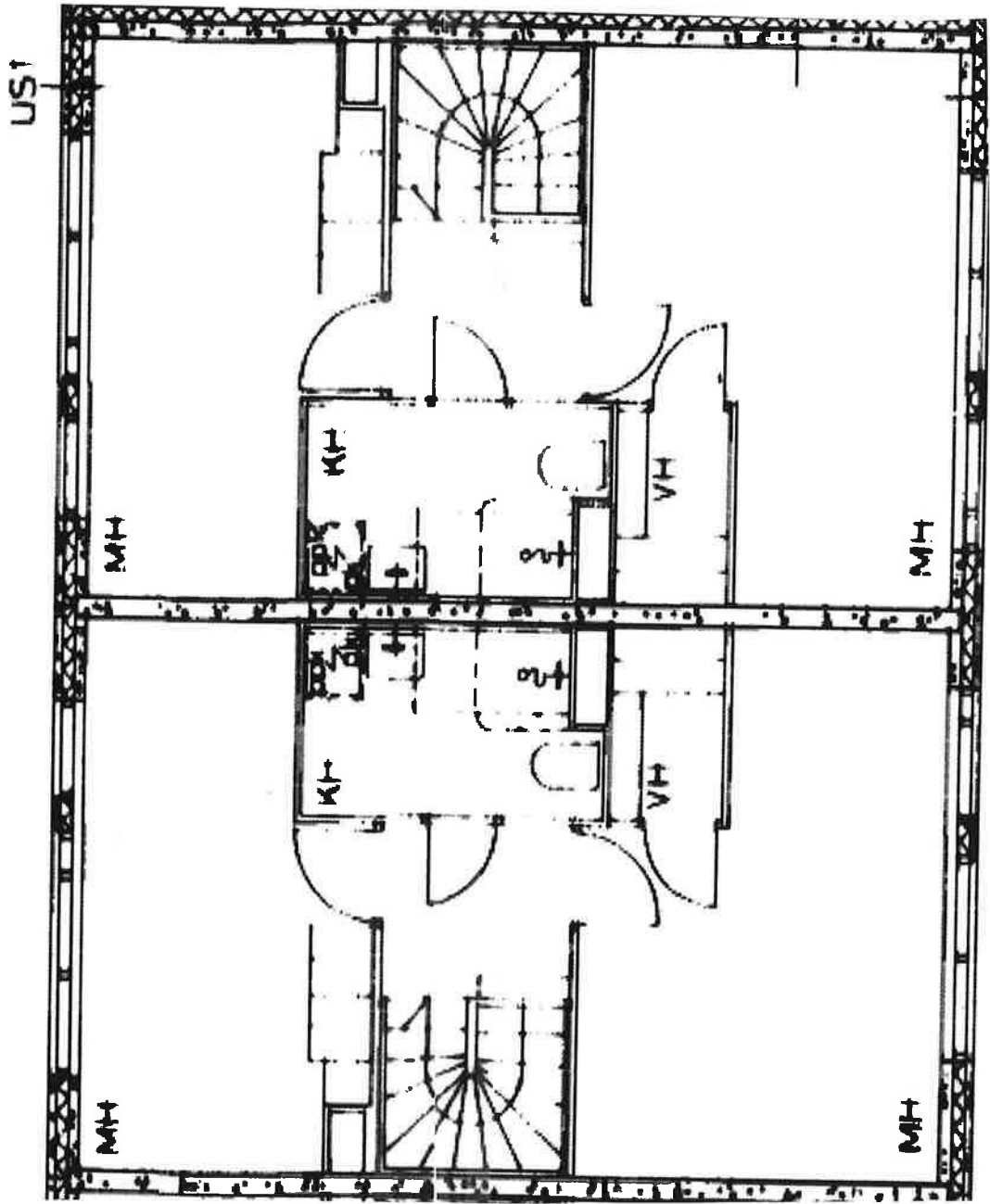

Parivalikantie 6 A 13 JA 14 2:kerros

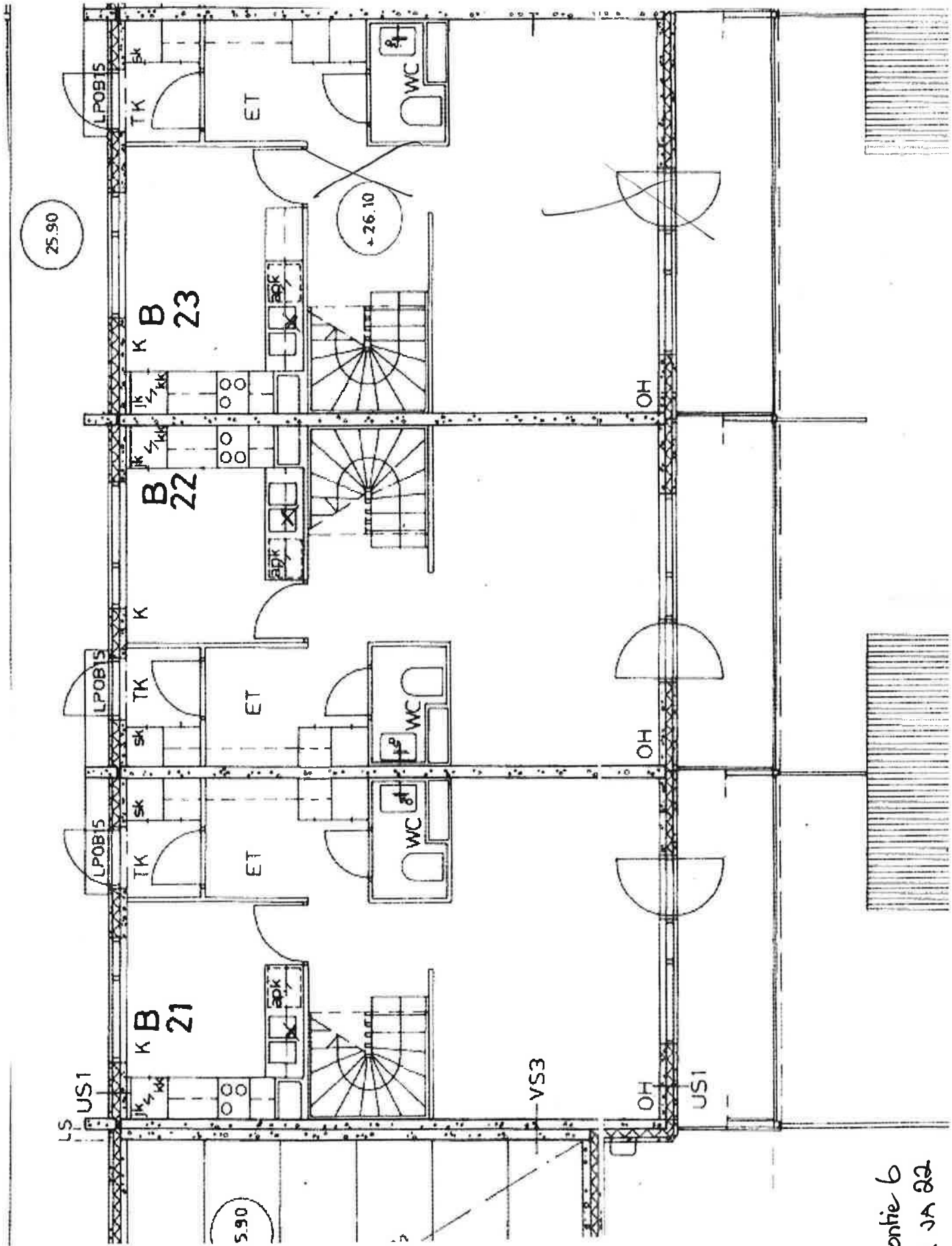

Parivaljakontie 6  
B 21 JA 22

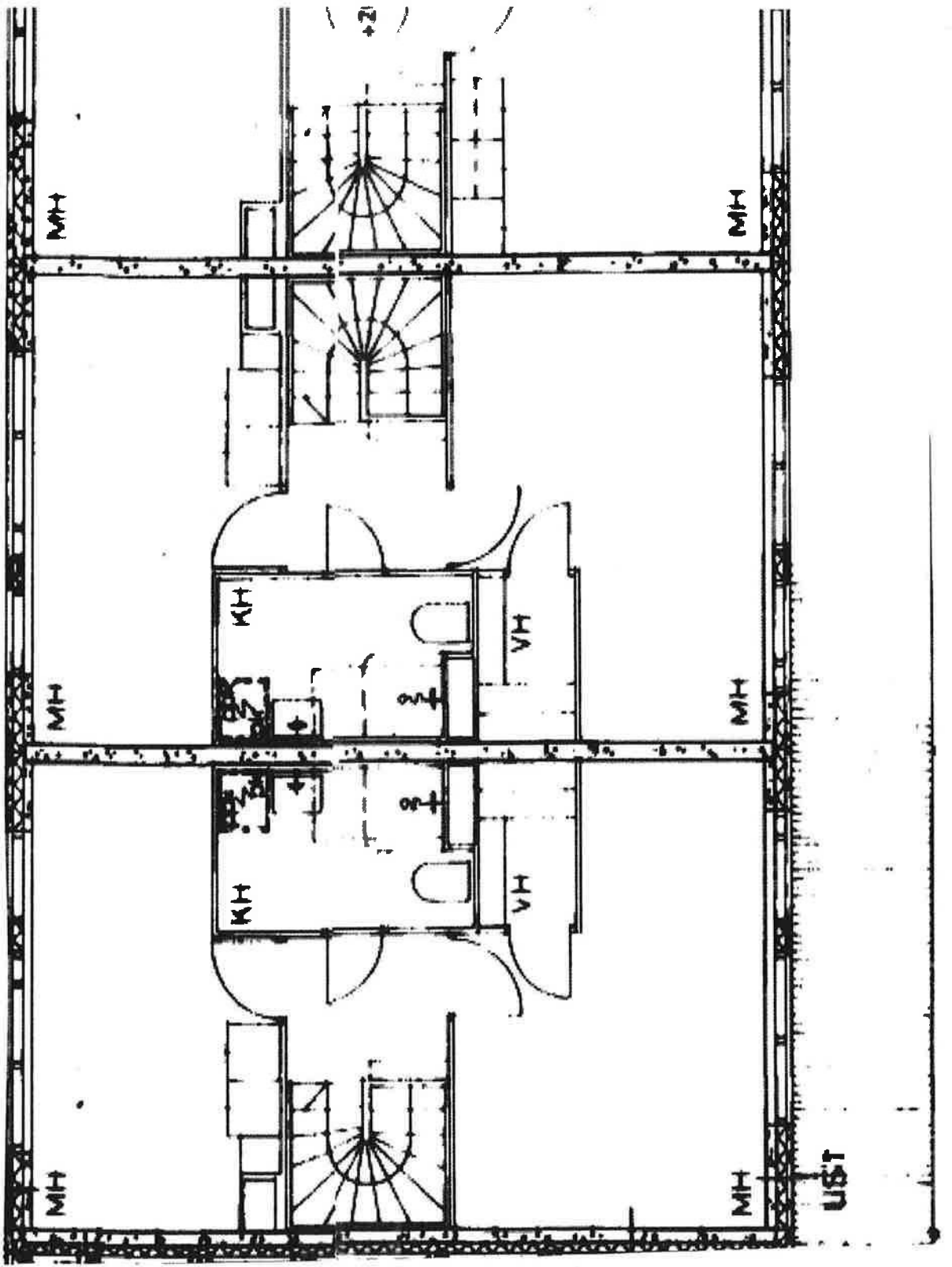

Parivaljakonte 6 B 21 ja 22

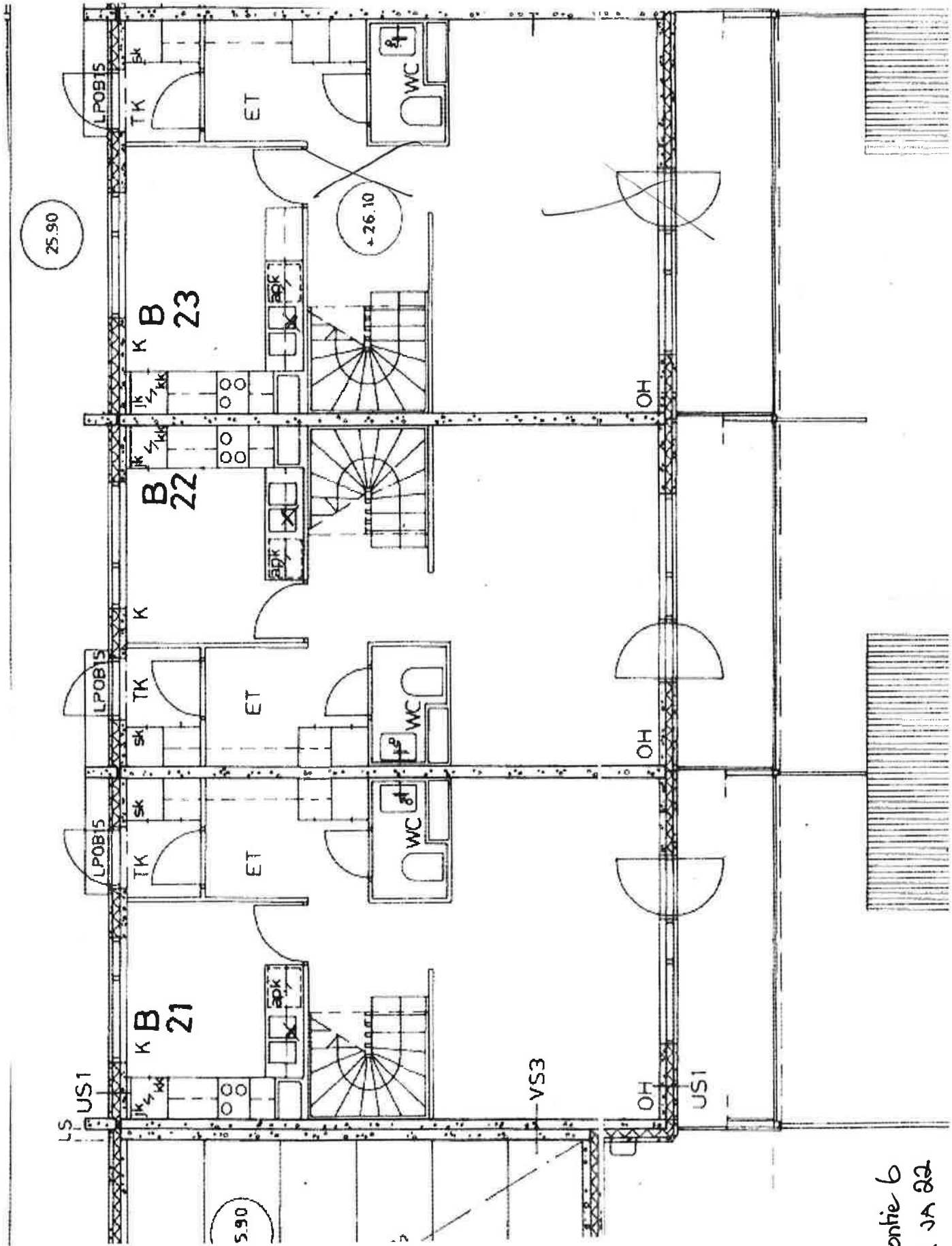

Parivaljakontie 6  
B 21 ja 22

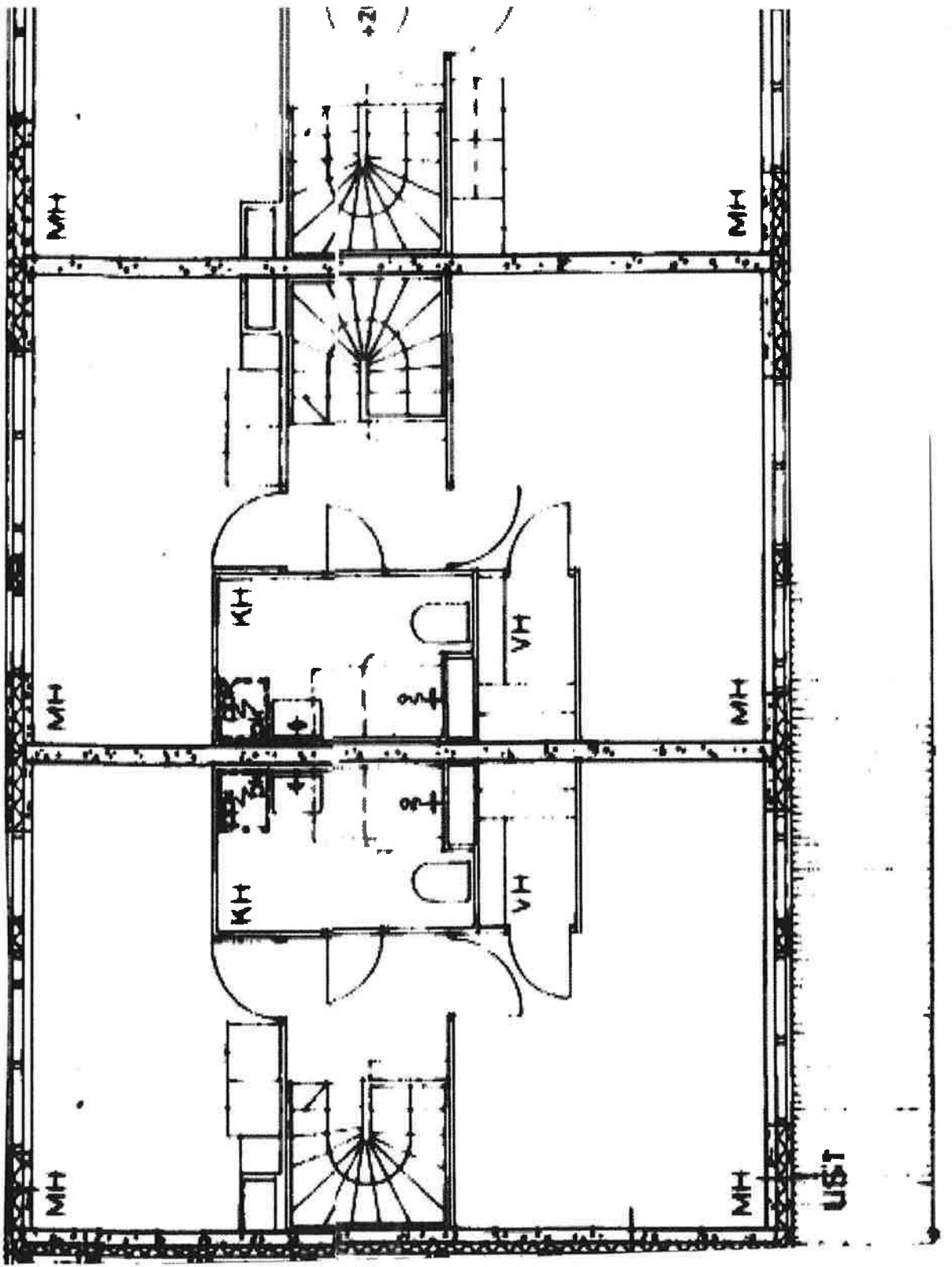

Parivaljakonte 6 B 21 JA 22

