

A4
2h + kk / 2A
32,5 m2

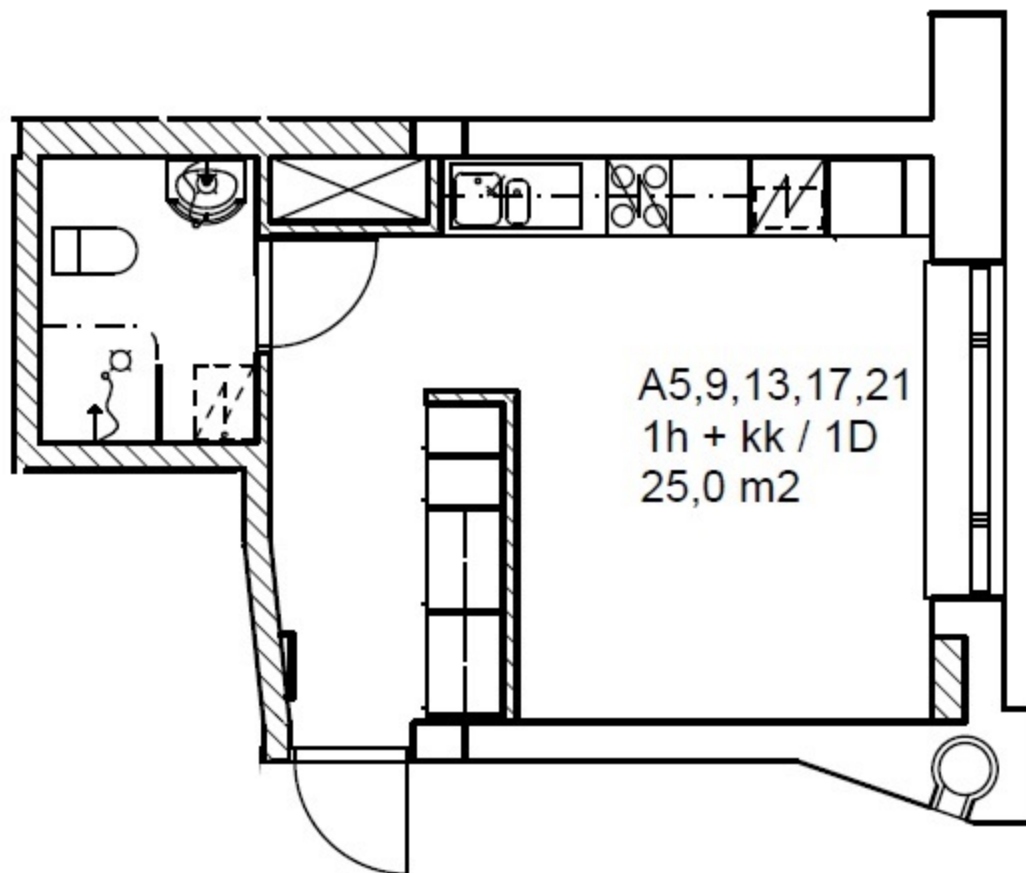

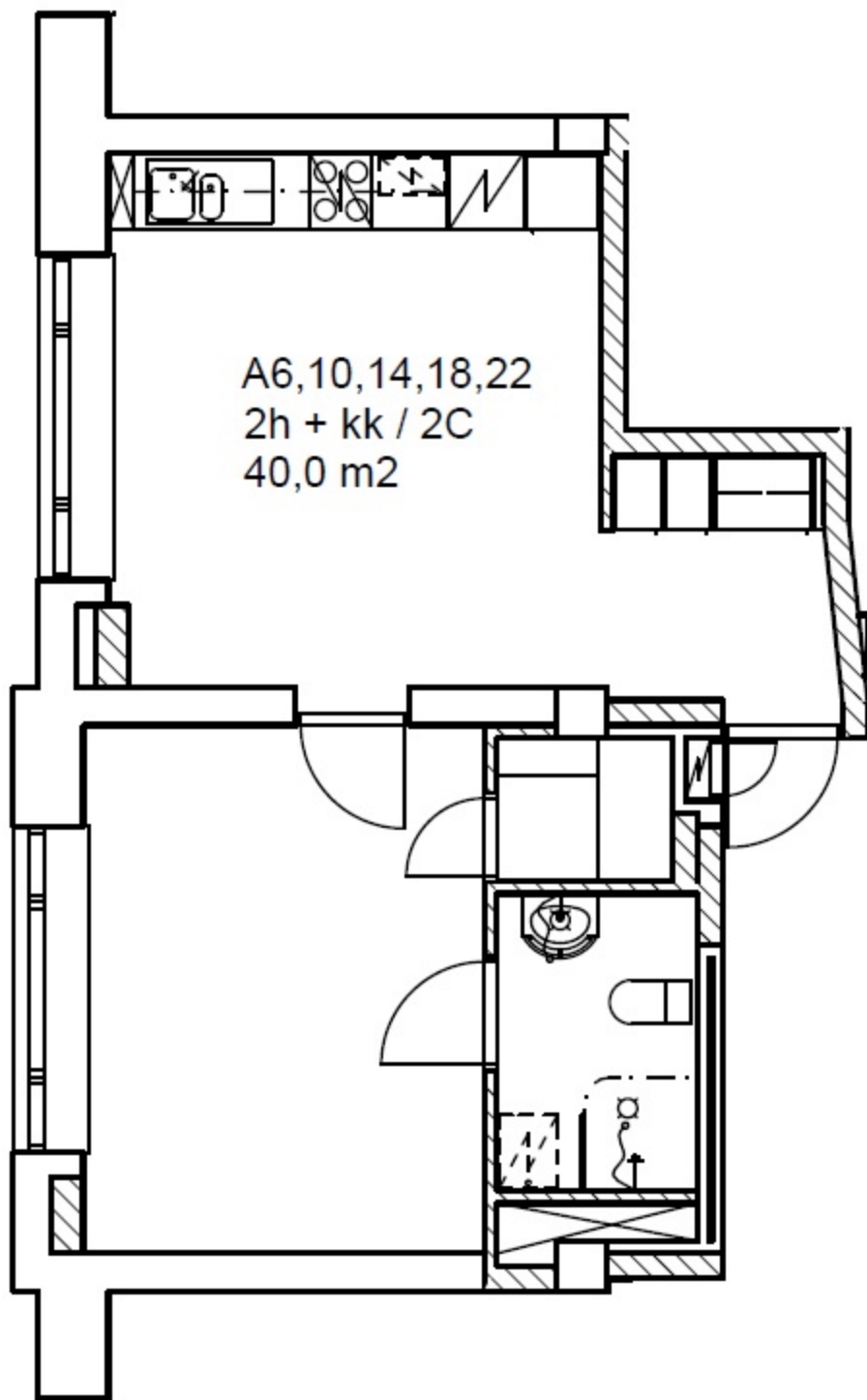

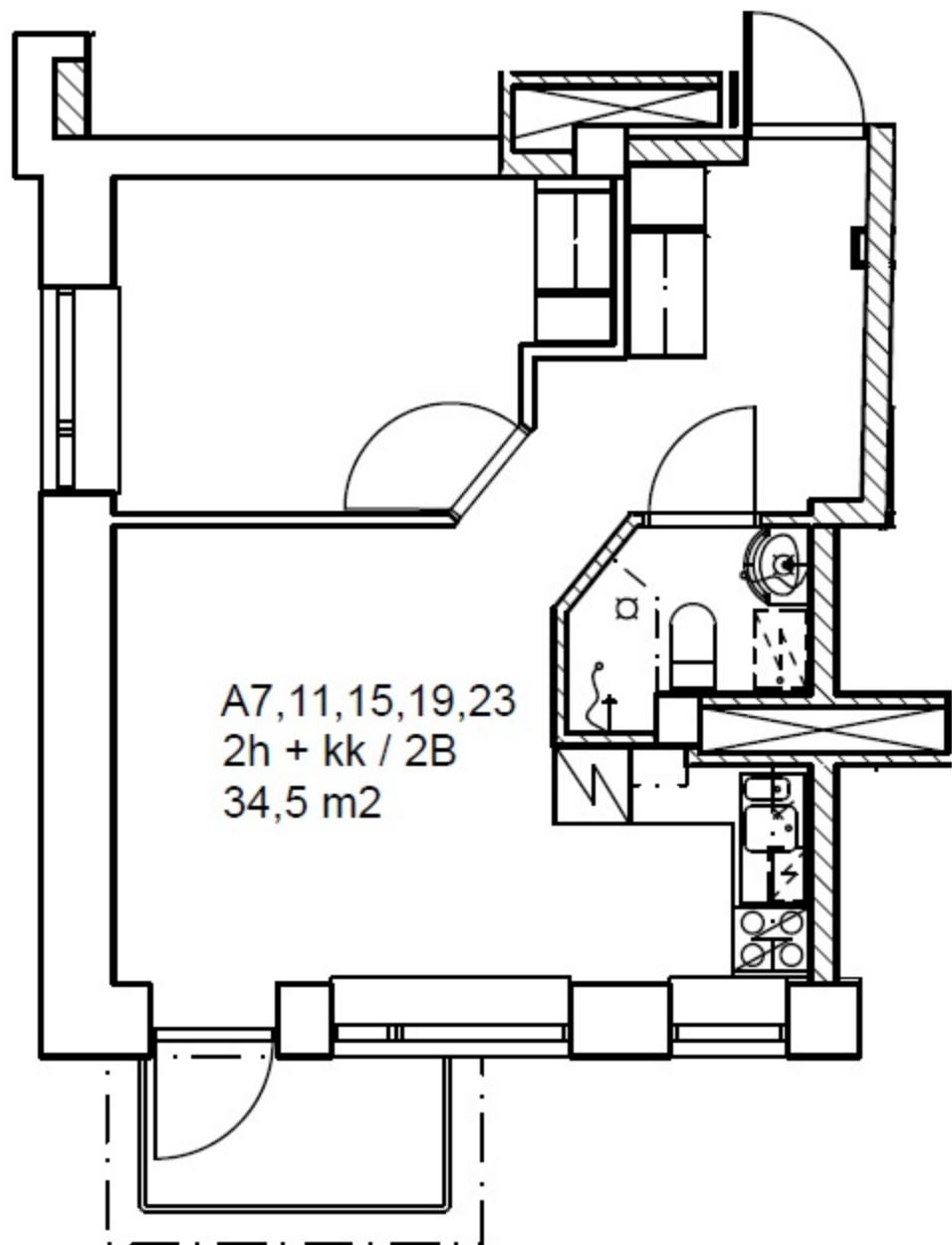

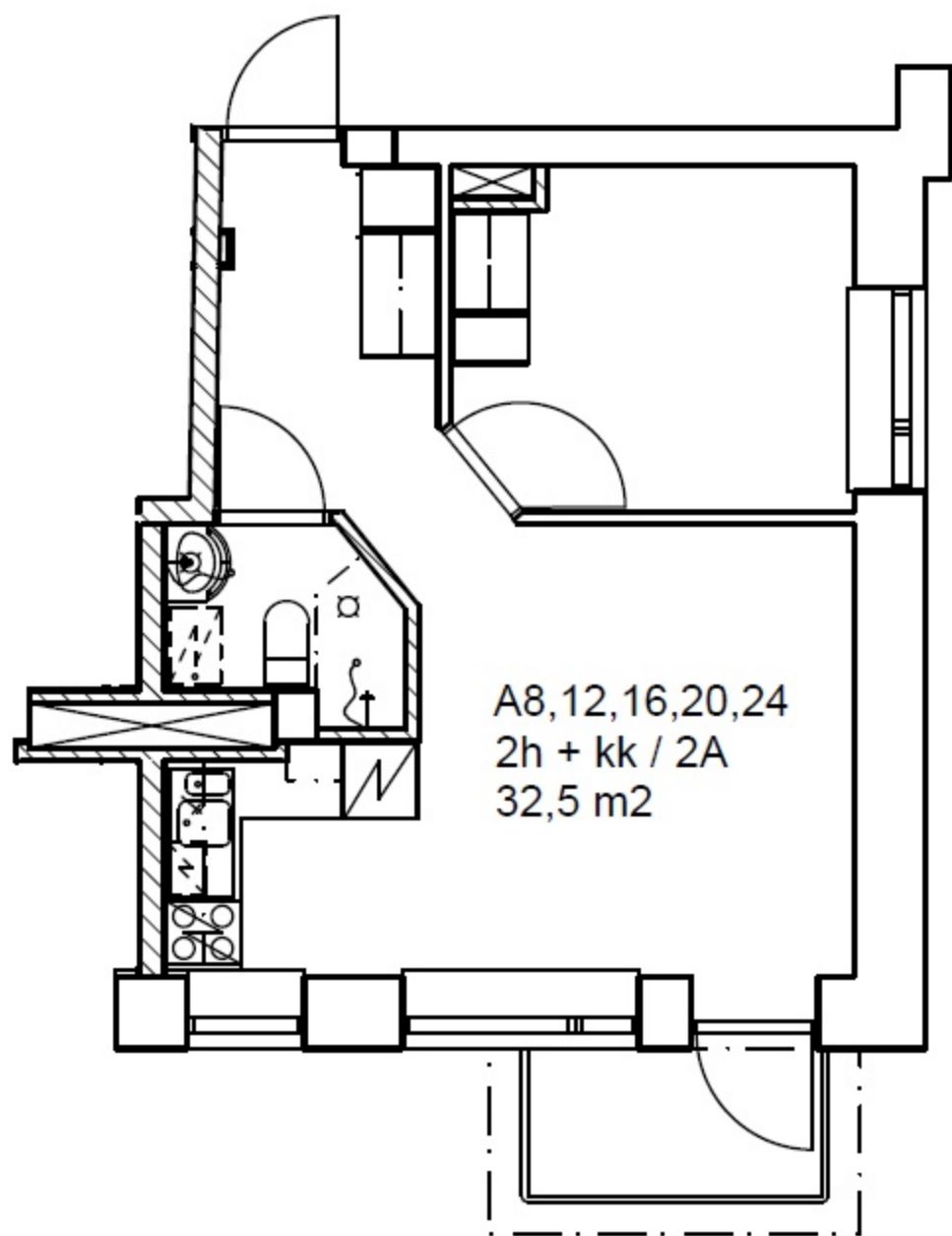

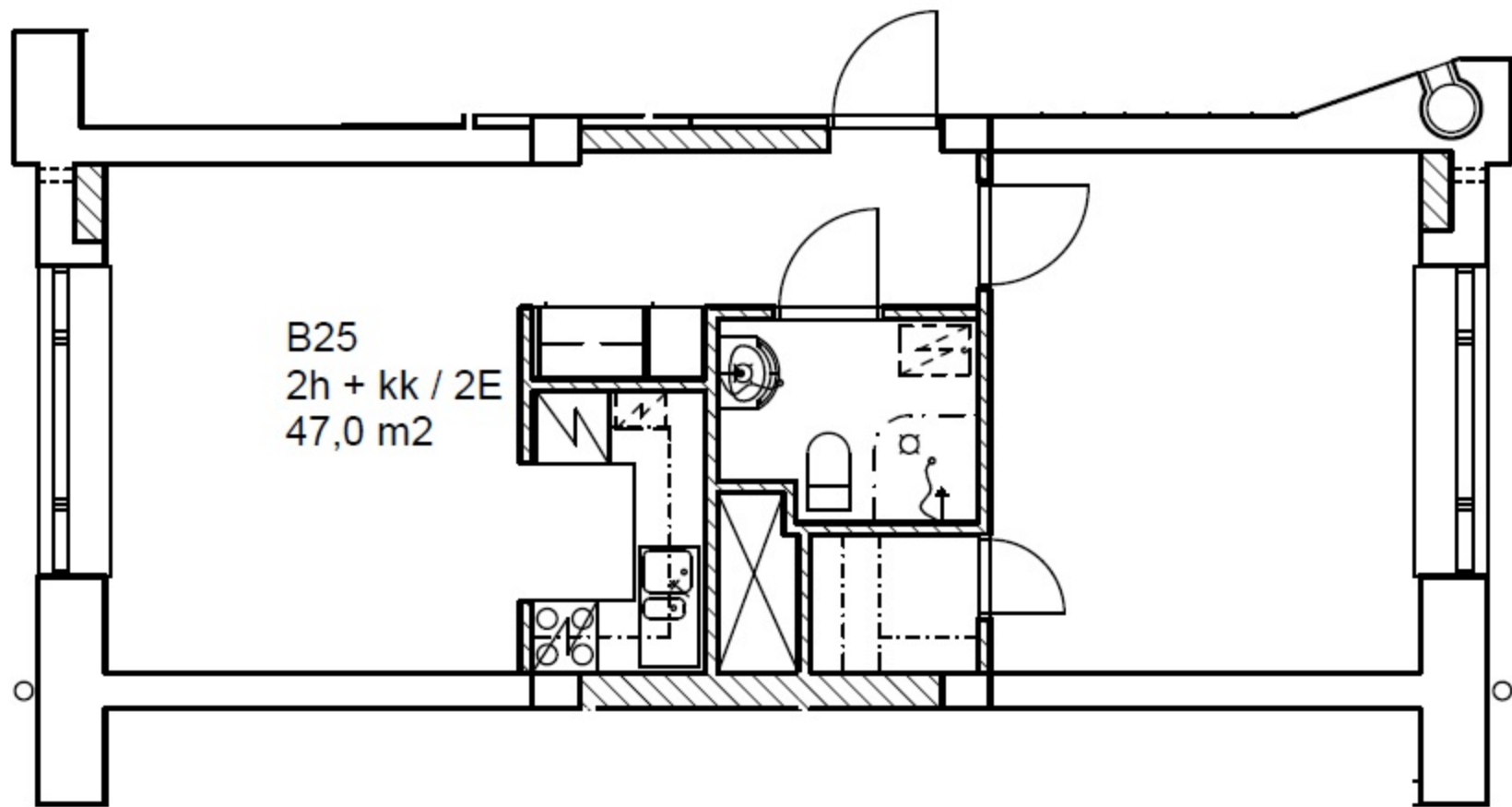

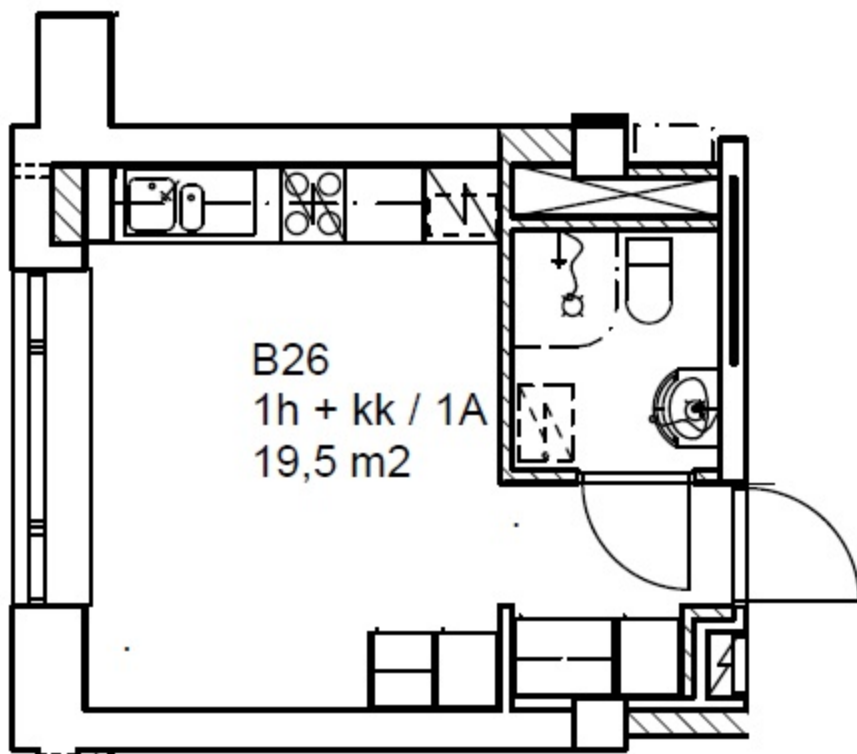

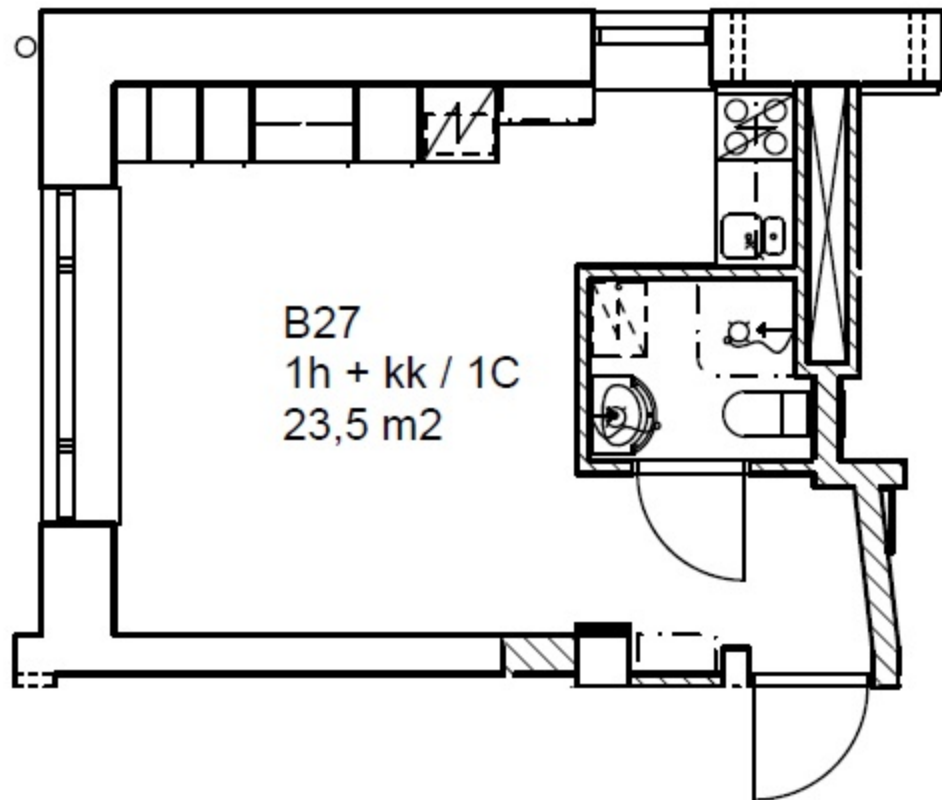

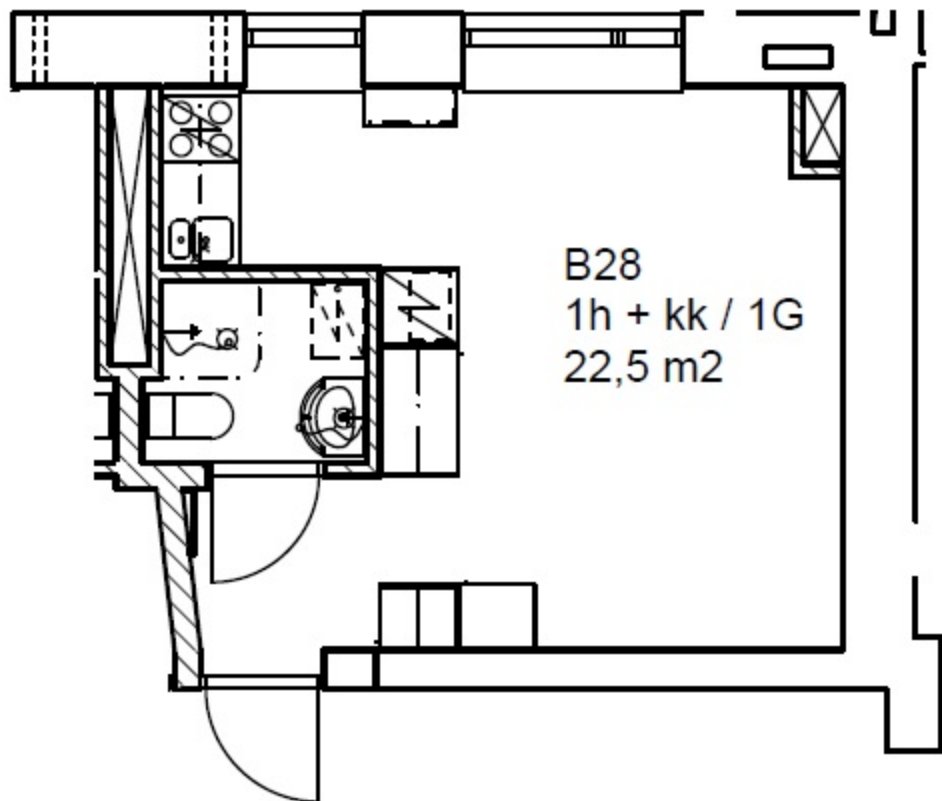

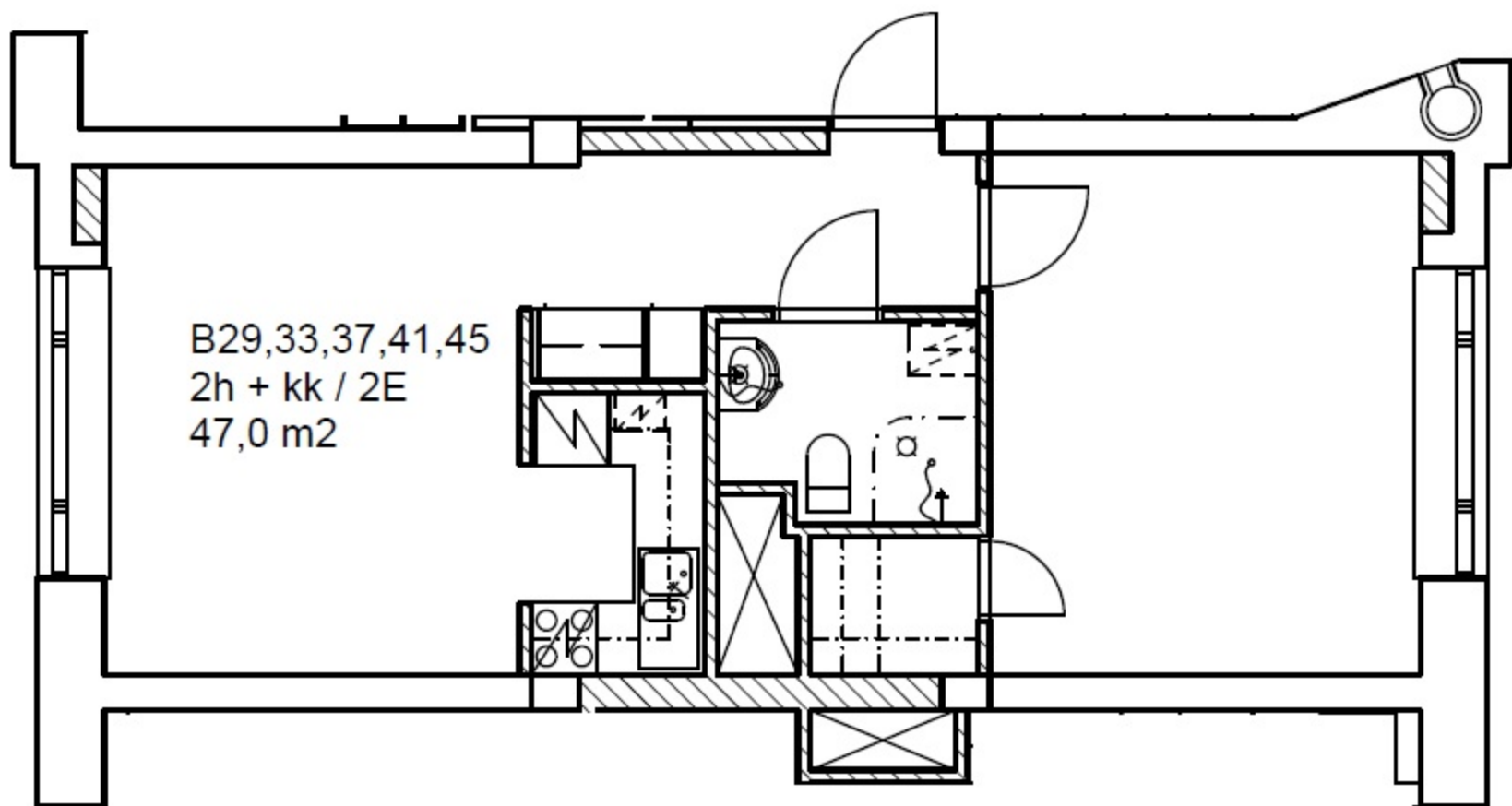

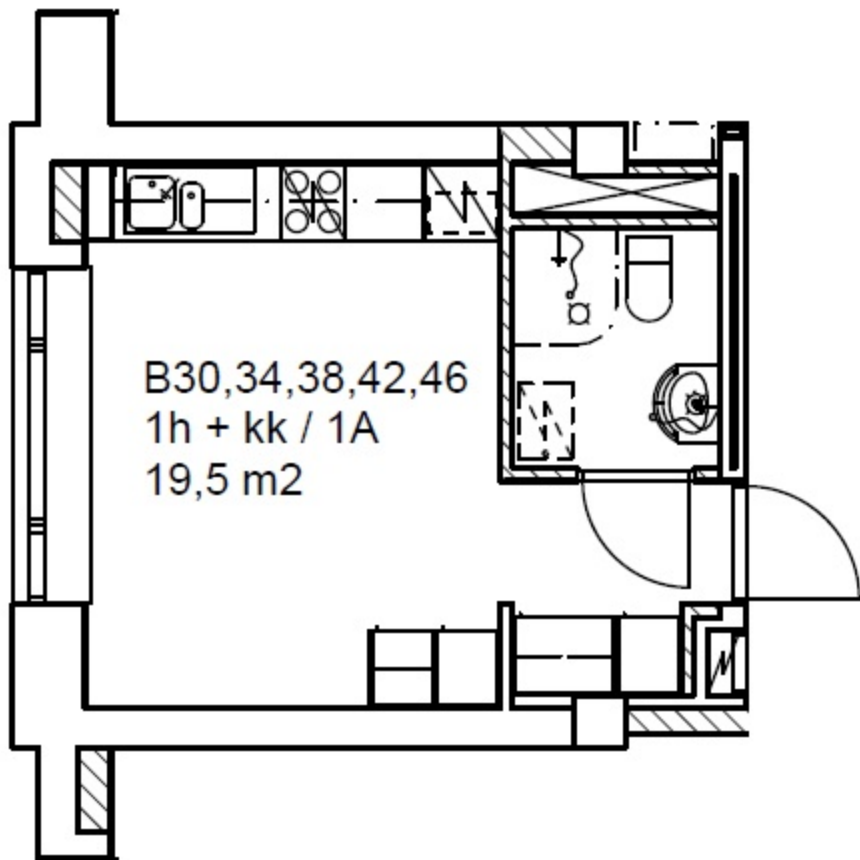

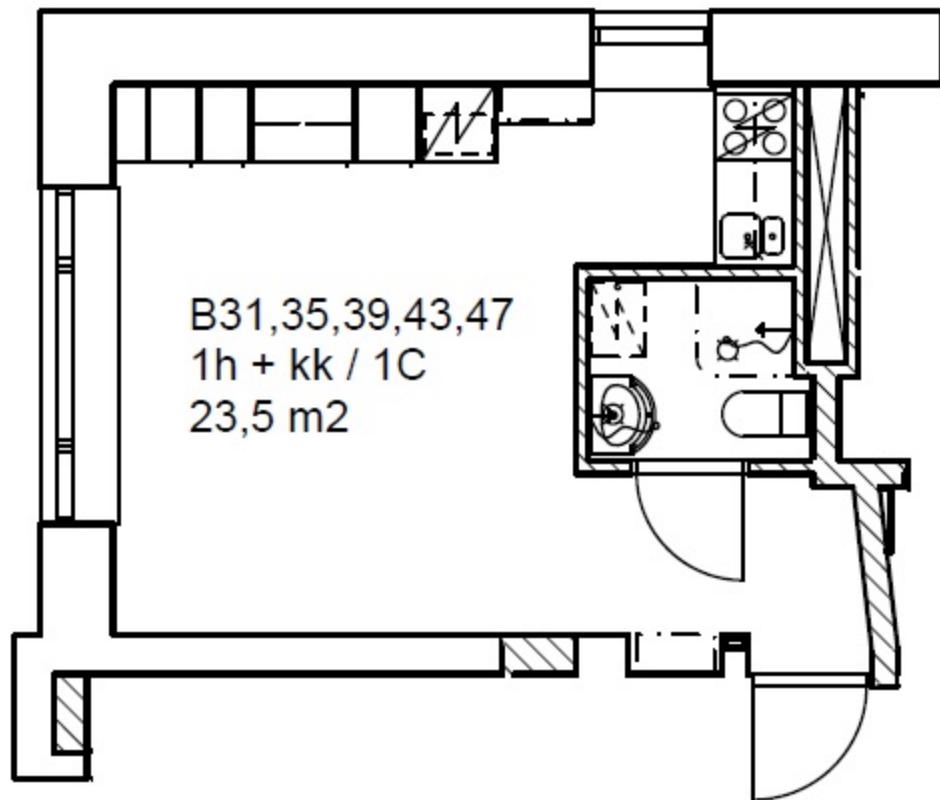

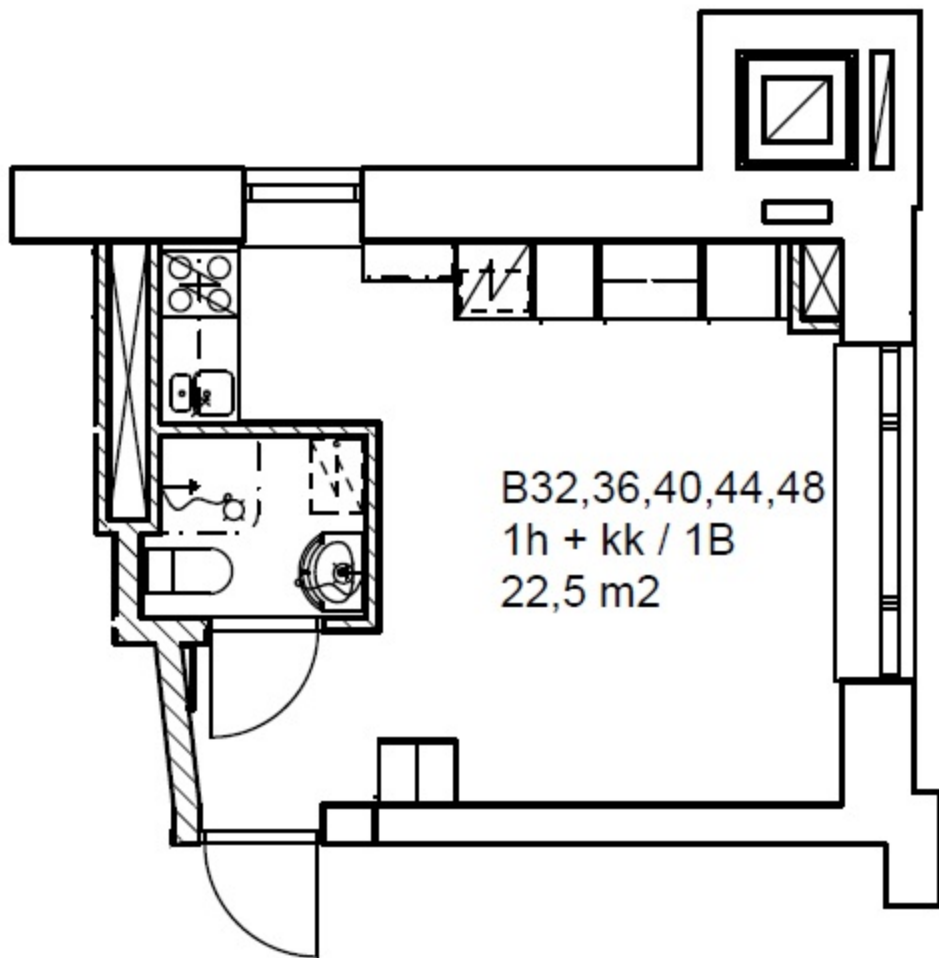

B32,36,40,44,48
1h + kk / 1B
22,5 m²

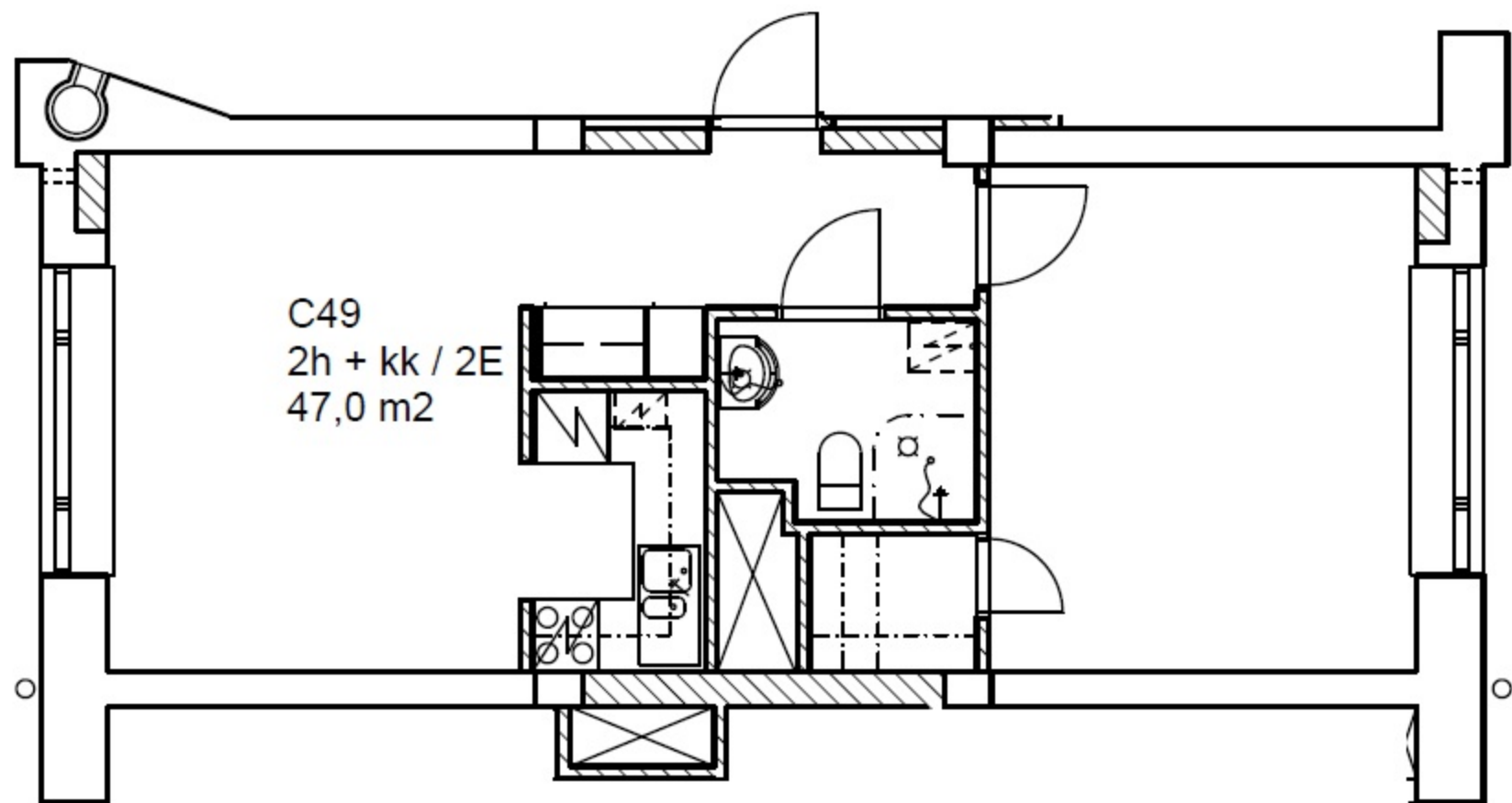

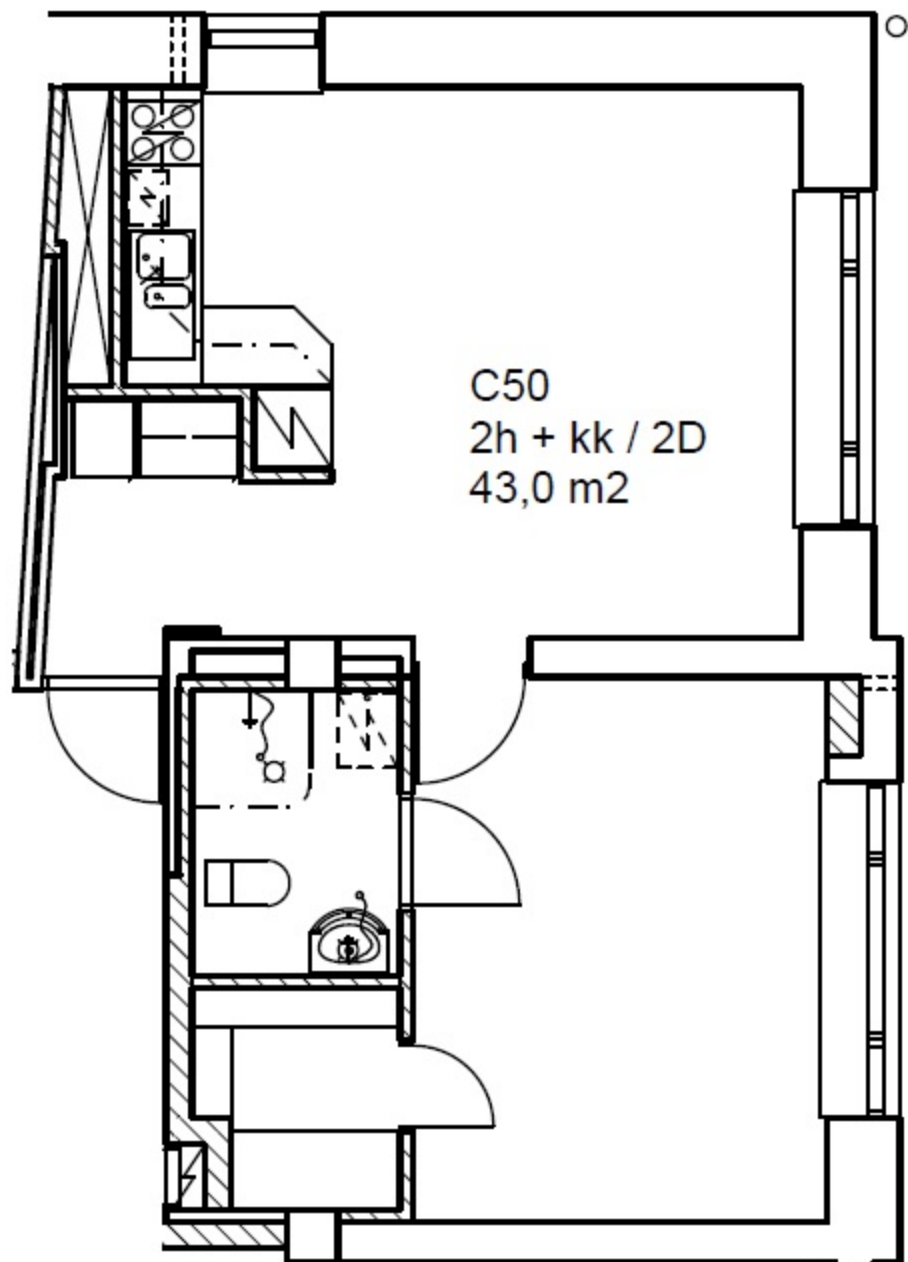

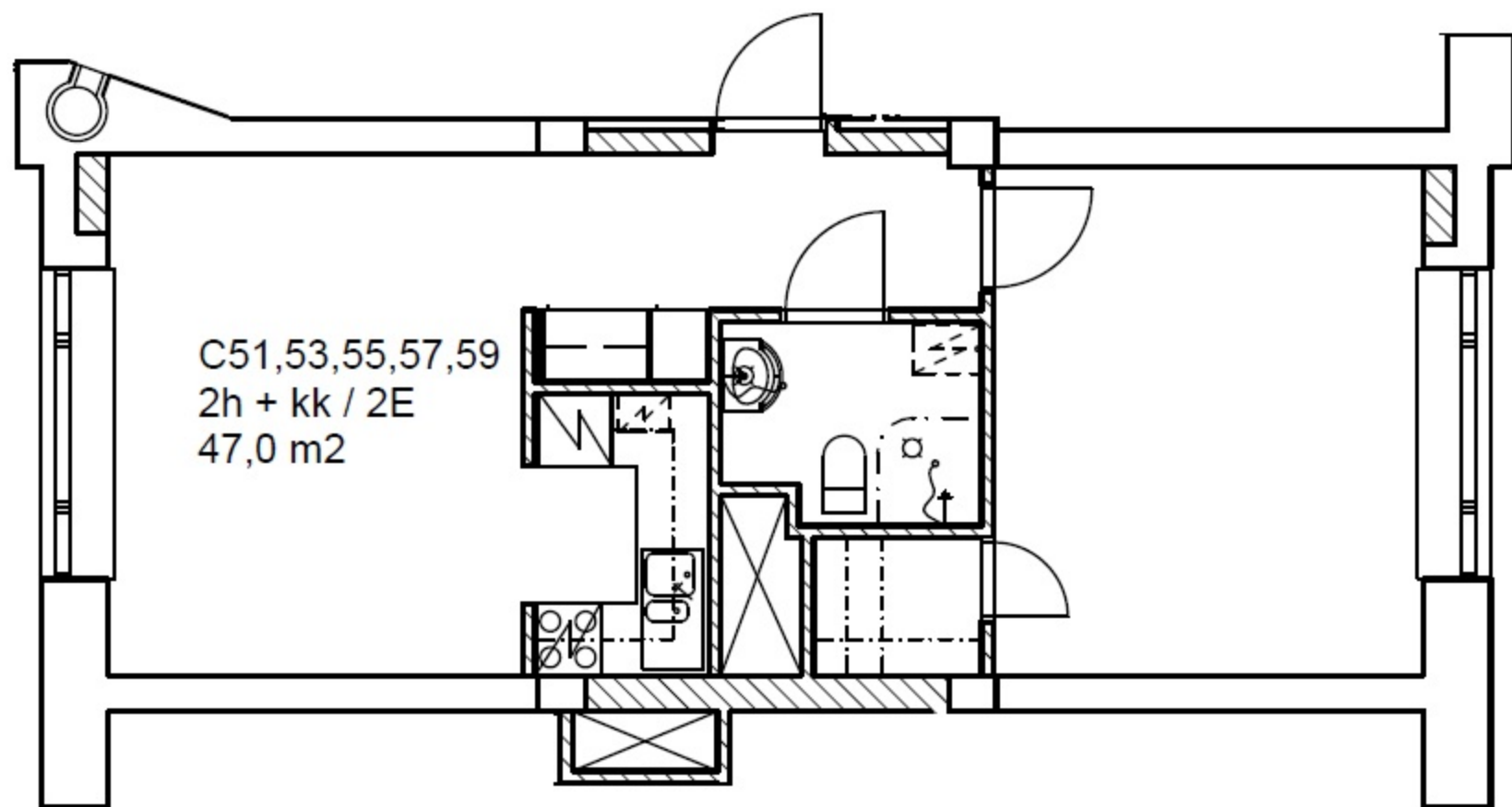

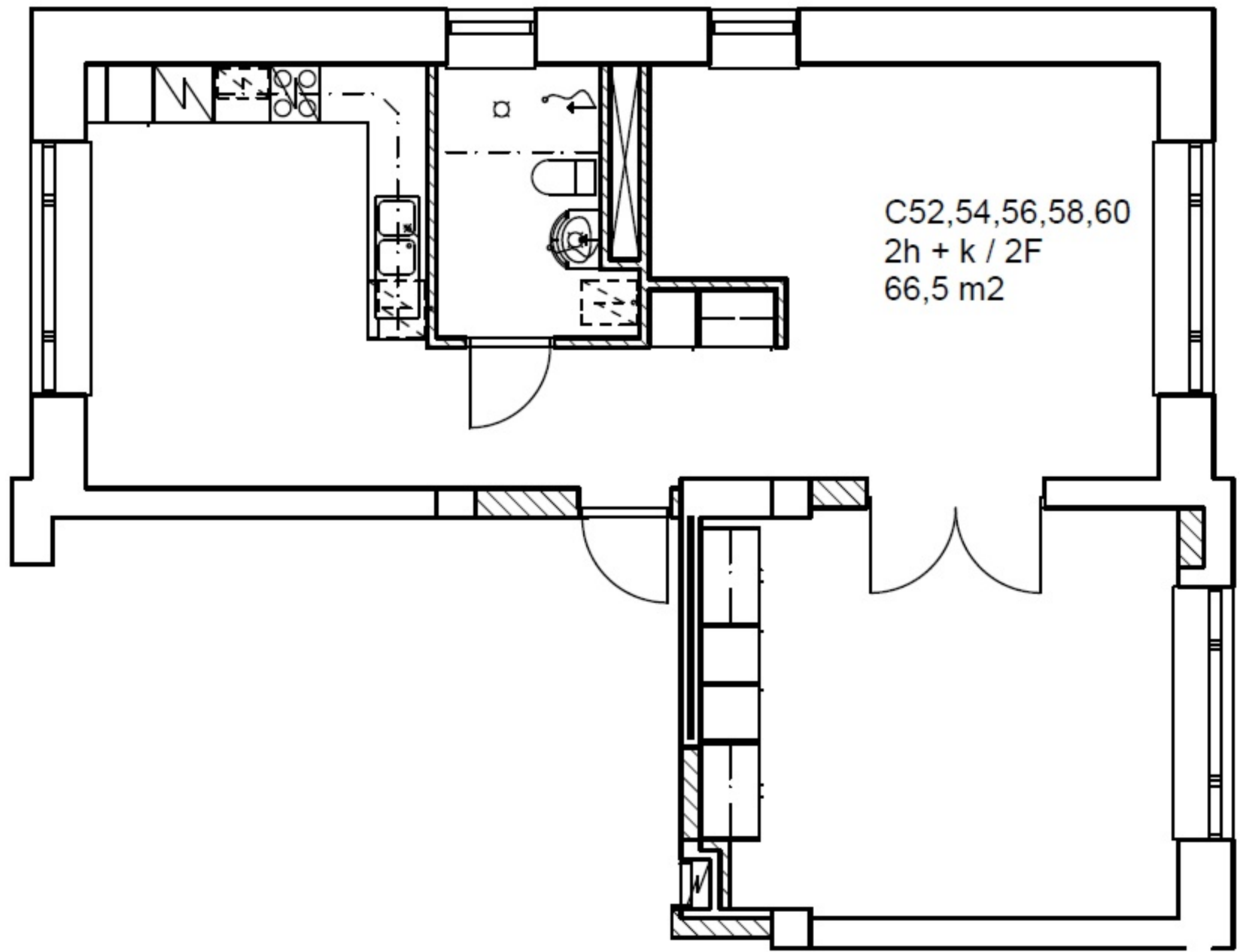

C52,54,56,58,60
2h + k / 2F
66,5 m2

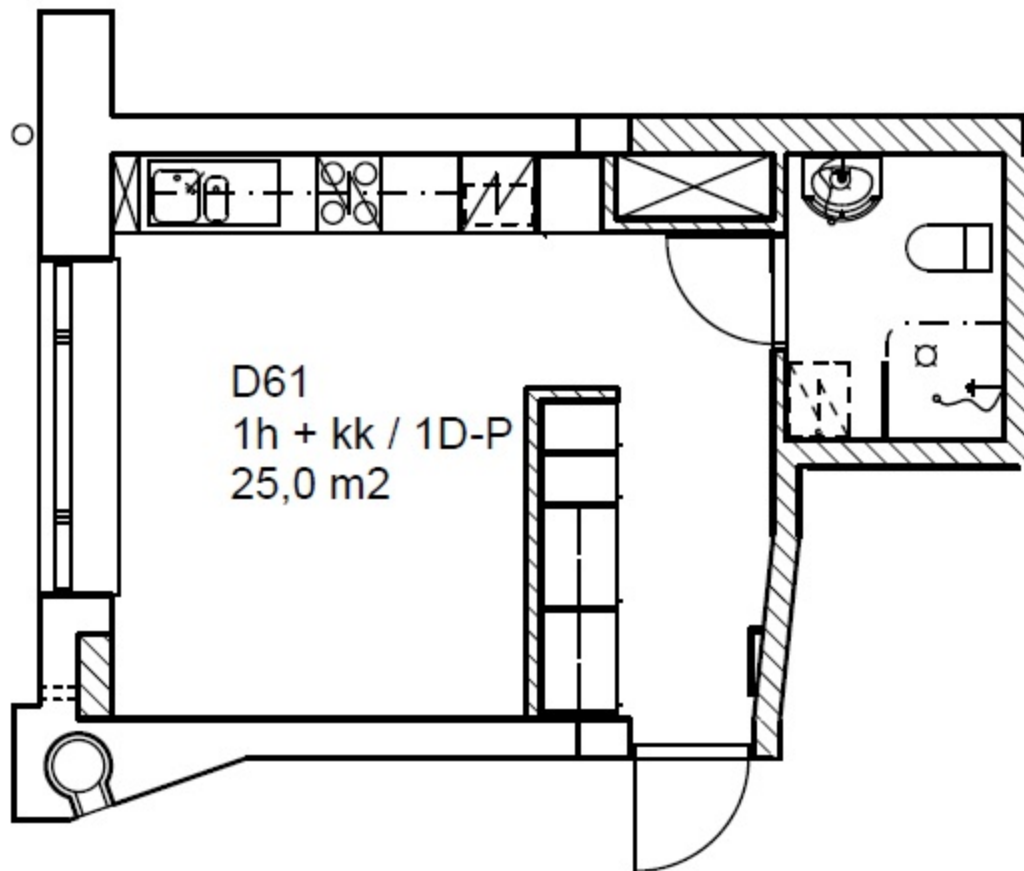

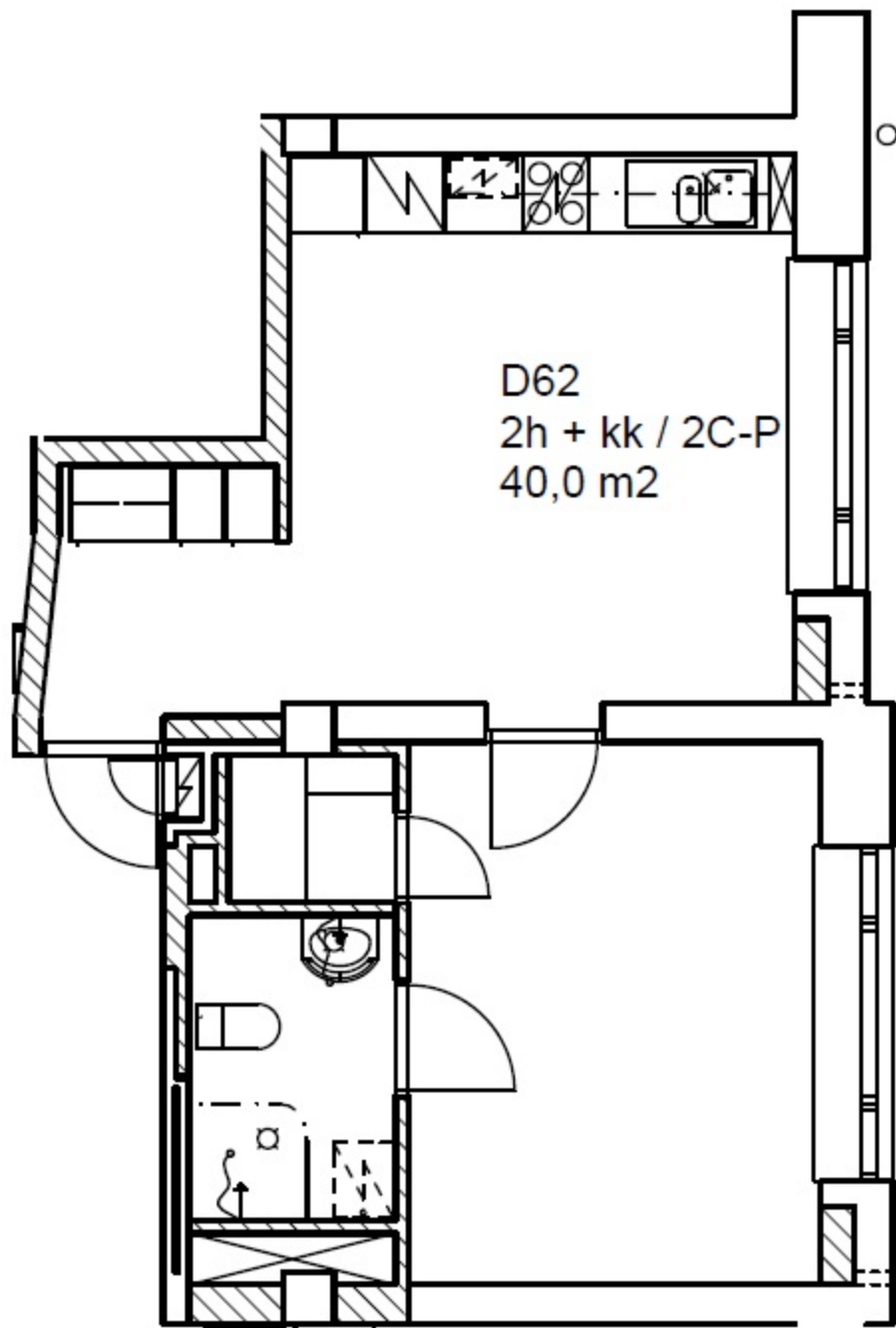

D62
2h + kk / 2C-P
40,0 m2

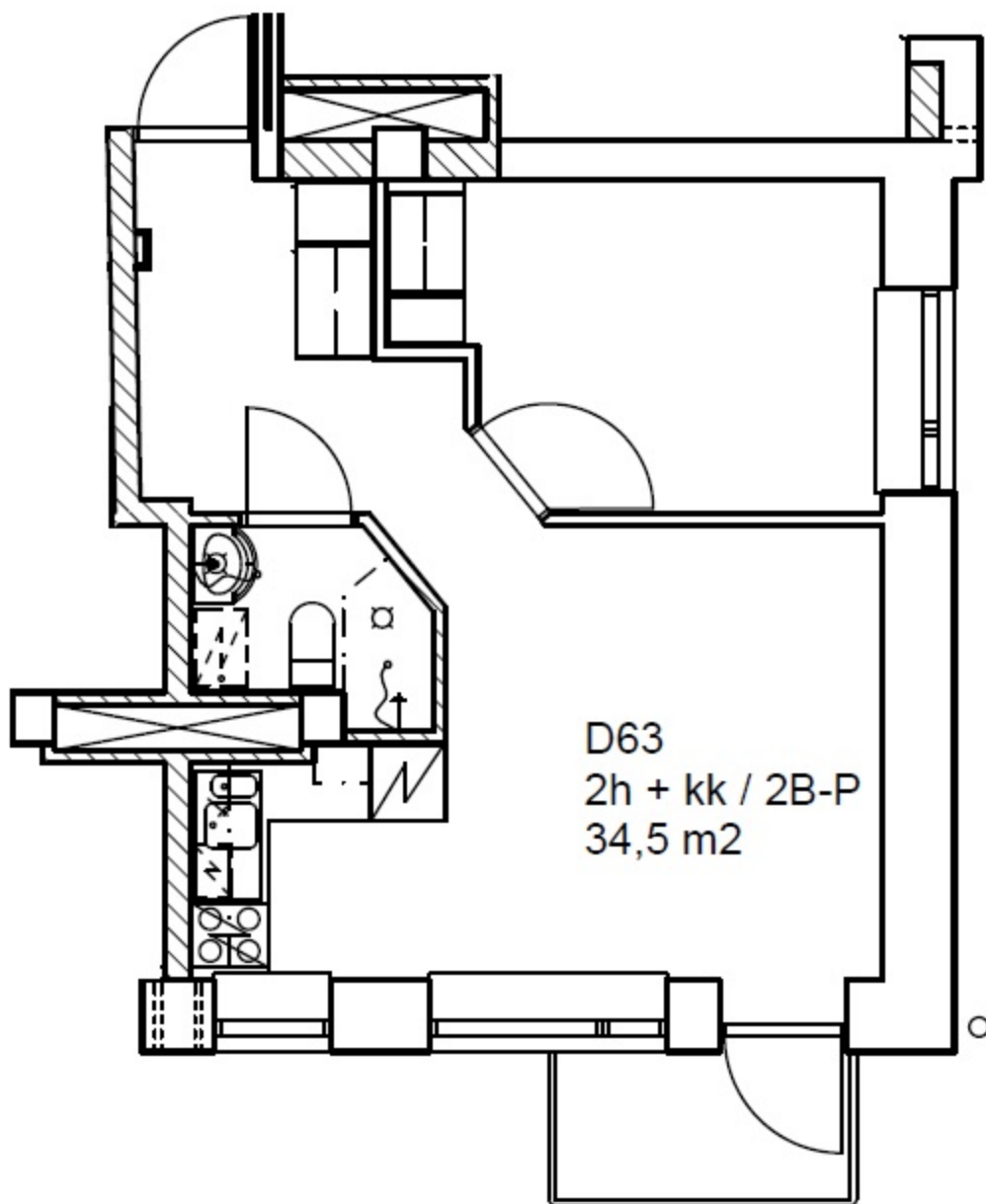

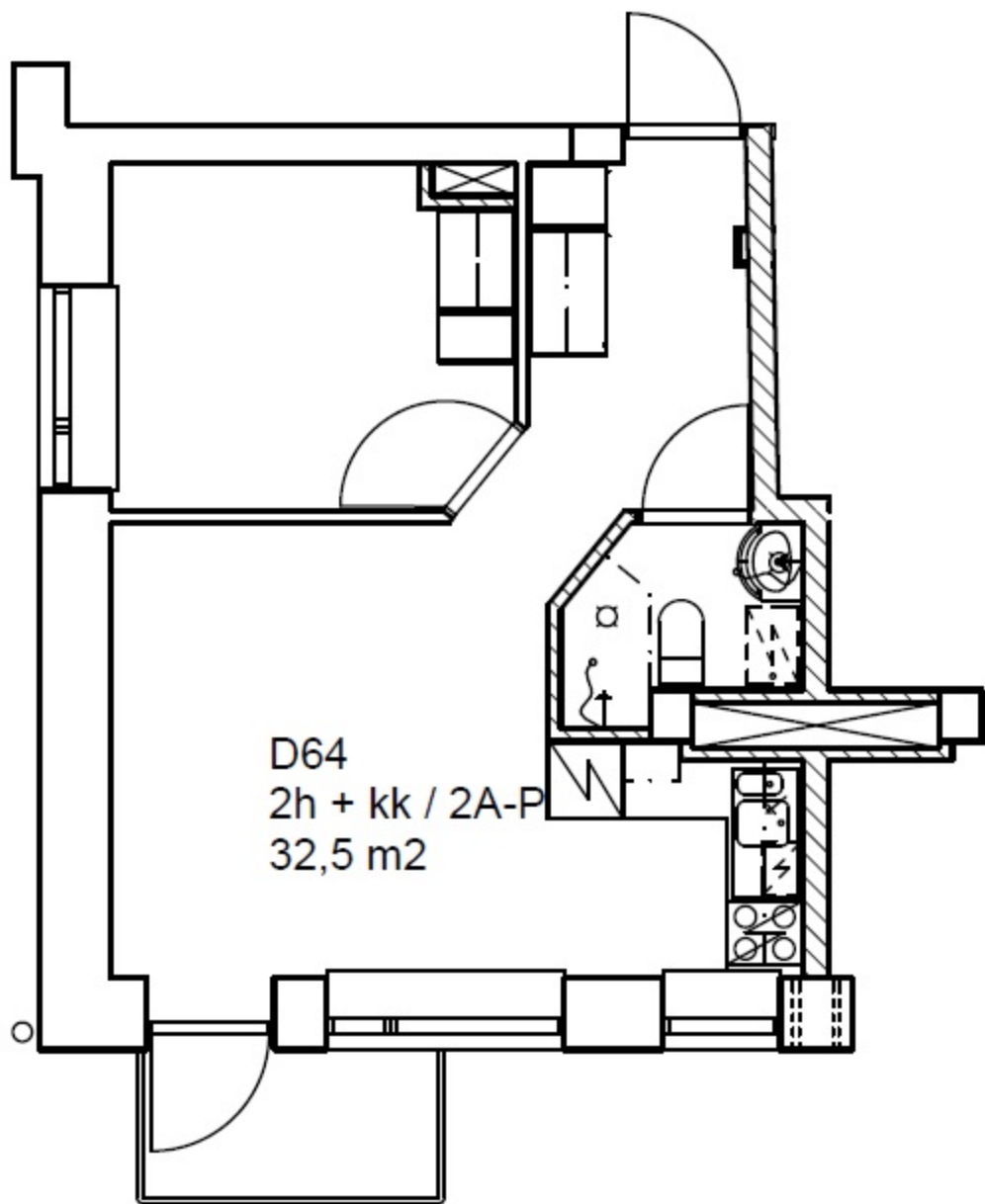

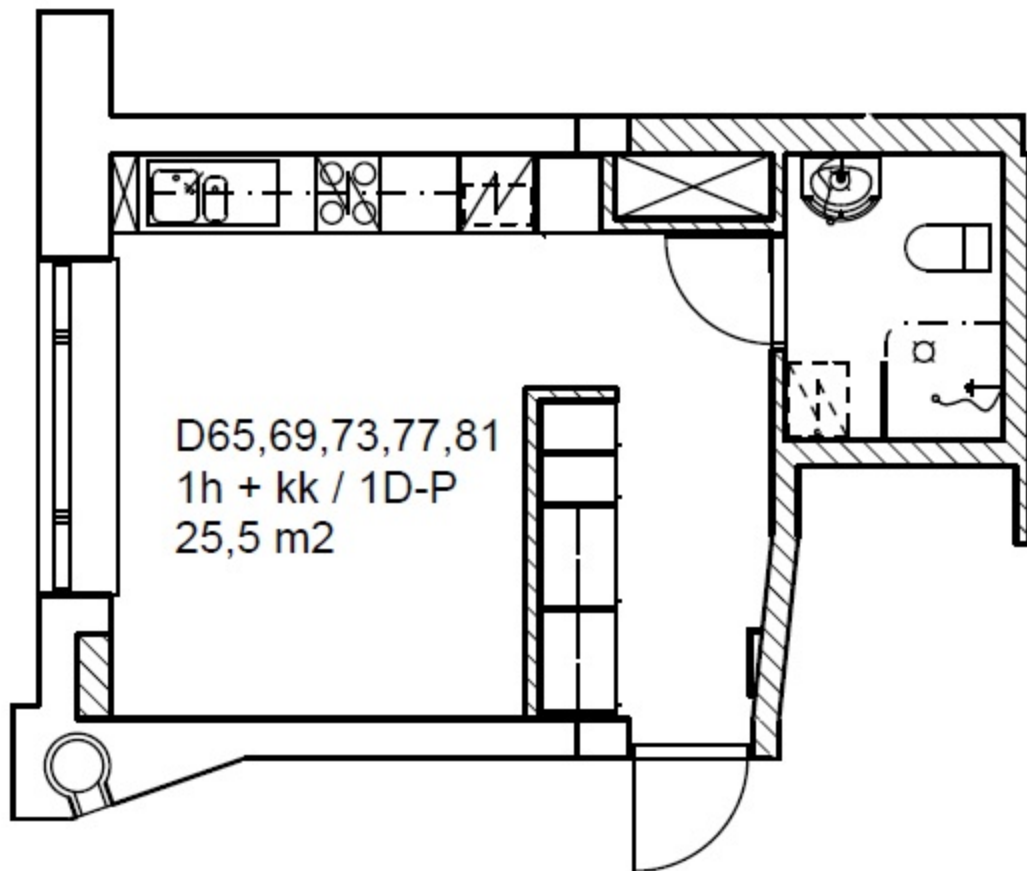

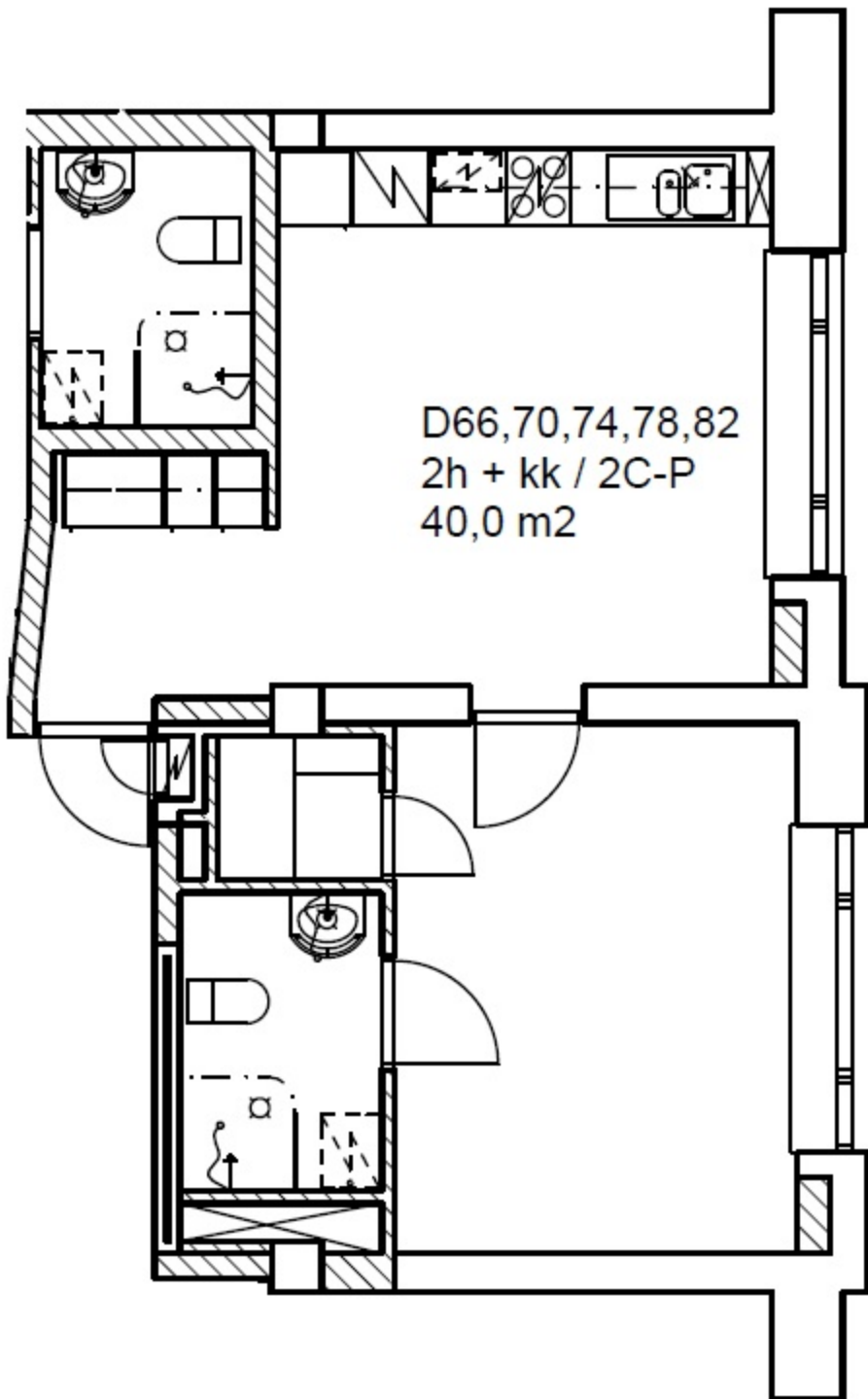

D66,70,74,78,82
2h + kk / 2C-P
40,0 m2

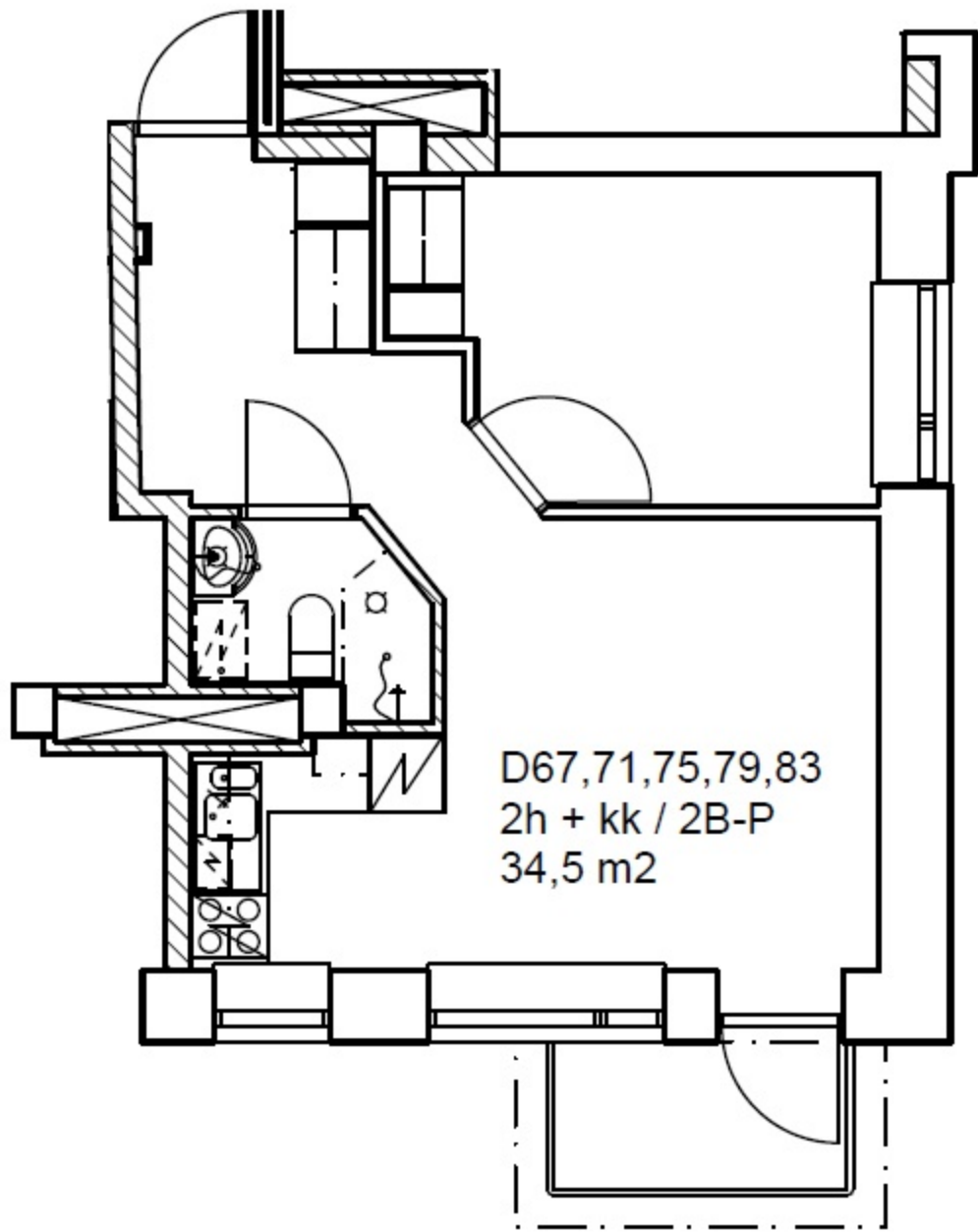

D67,71,75,79,83
2h + kk / 2B-P
34,5 m²

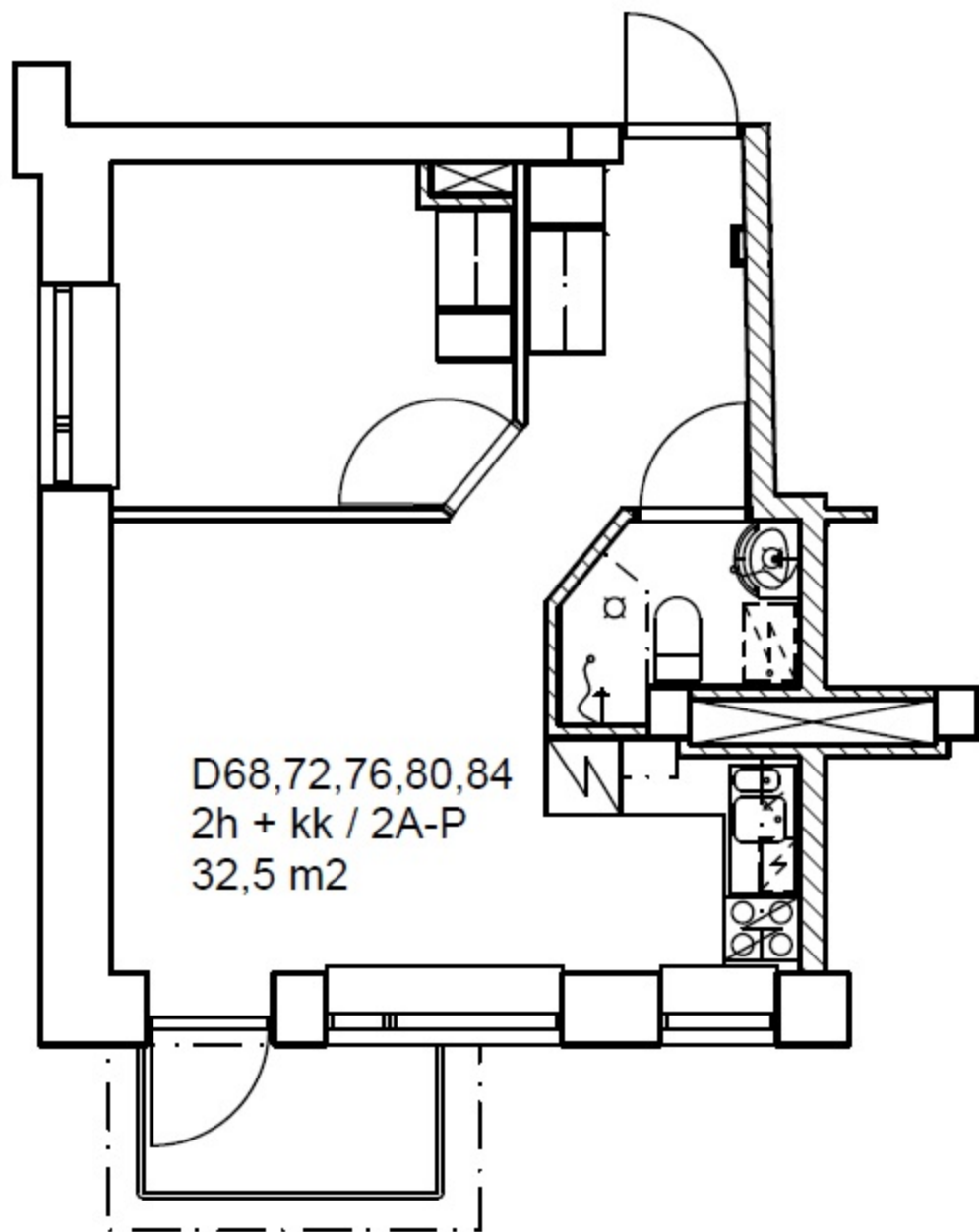

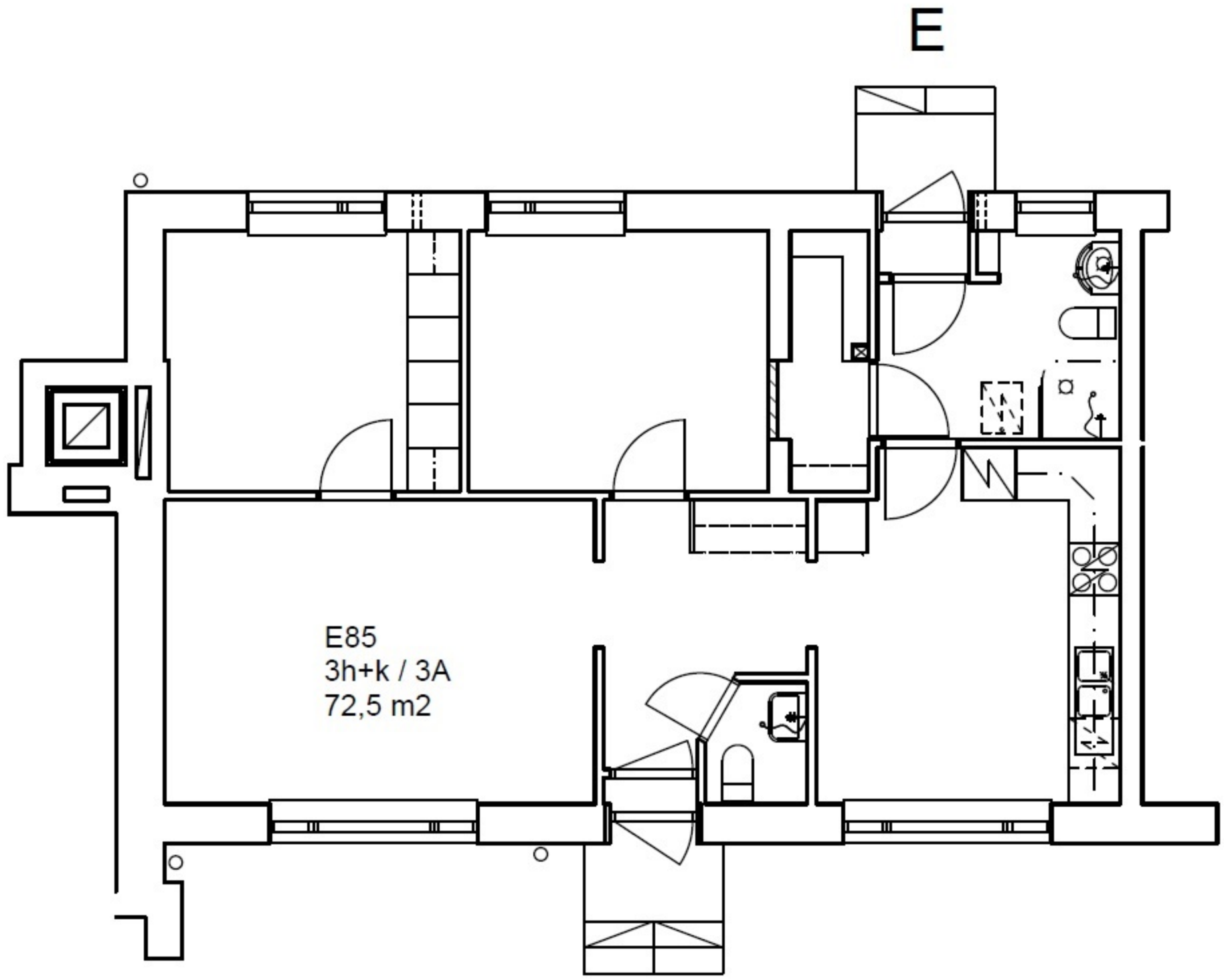

E85
3h+k / 3A
72,5 m2

E

F

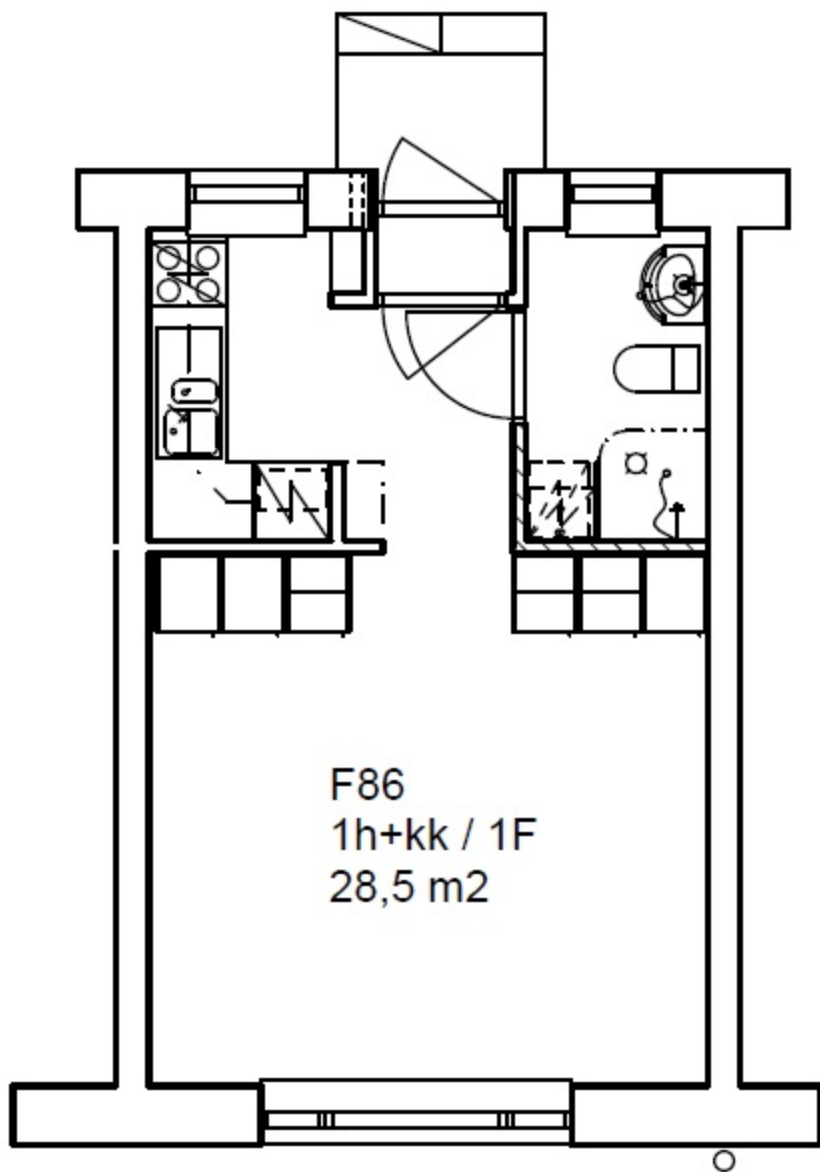

G

