

31.10.2018

# HEKA Risupadontie

Risupadontie 3, 00640 Helsinki

3H + KT 69,5 m<sup>2</sup>

Huoneistopohja 1 : 100

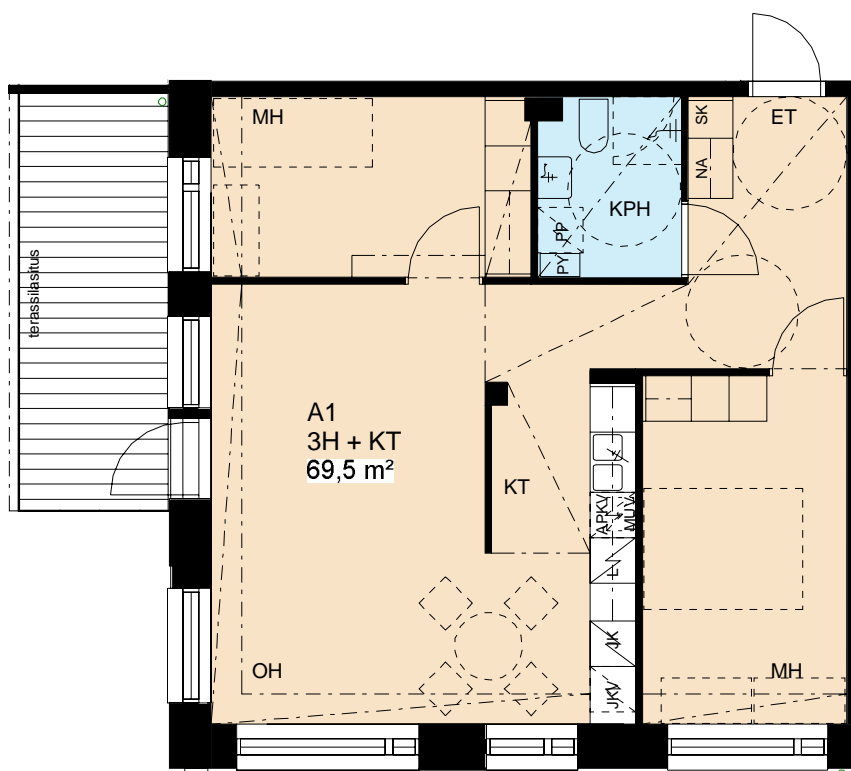
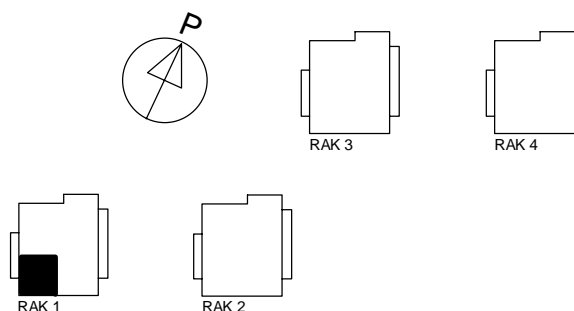

A1 1. KERROS

VÄHÄISET RAKENNUSAIKAISET MUUTOKSET MAHDOLLISIA

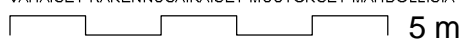

ARKKITEHTITOIMISTO HEDMAN & MATOMÄKI

31.10.2018

# HEKA Risupadontie

Risupadontie 3, 00640

Helsinki

3H + KT 74,0 m<sup>2</sup>

Huoneistopohja 1 : 100

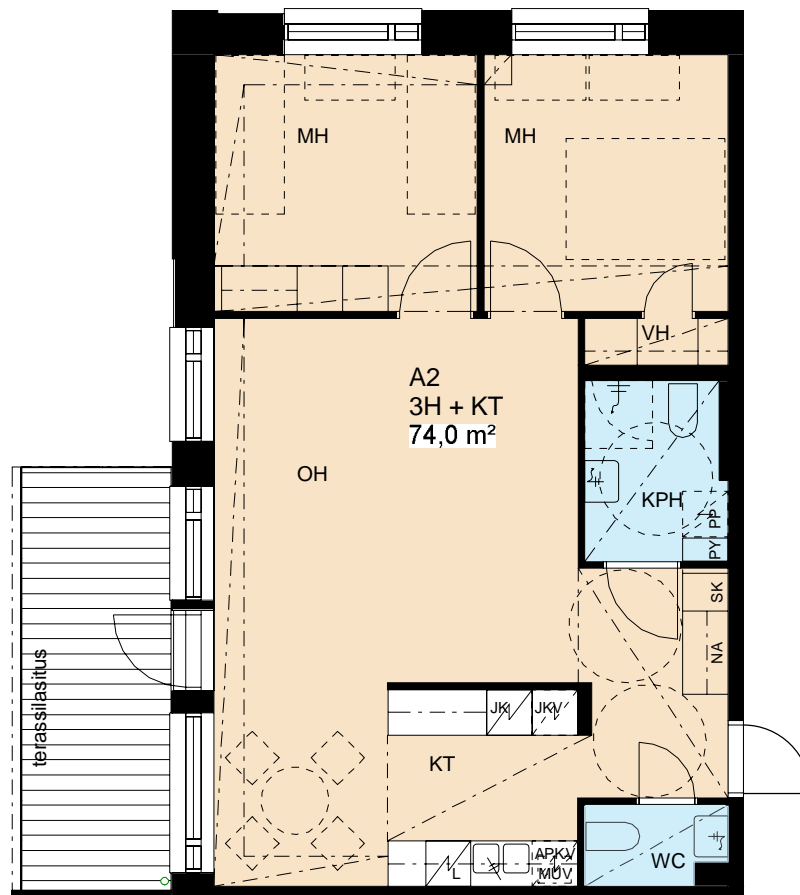
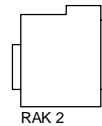
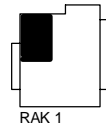
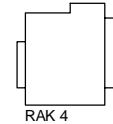

A2 1. KERROS

VÄHÄISET RAKENNUSAIKAISET MUUTOKSET MAHDOLLISIA



ARKKITEHTITOIMISTO HEDMAN & MATOMÄKI

31.10.2018

# HEKA Risupadontie

Risupadontie 3, 00640

Helsinki

3H + KT 74,0 m<sup>2</sup>

Huoneistopohja 1 : 100

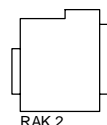
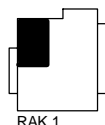
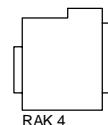
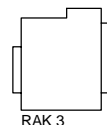

A3 2. KERROS  
A8 3. KERROS  
A13 4. KERROS

VÄHÄISET RAKENNUSAIKAISET MUUTOKSET MAHDOLLISIA



ARKKITEHTITOIMISTO HEDMAN & MATOMÄKI

31.10.2018

## HEKA Risupadontie

Risupadontie 3, 00640

Helsinki

3H + KT 69,0 m<sup>2</sup>

Huoneistopohja 1 : 100

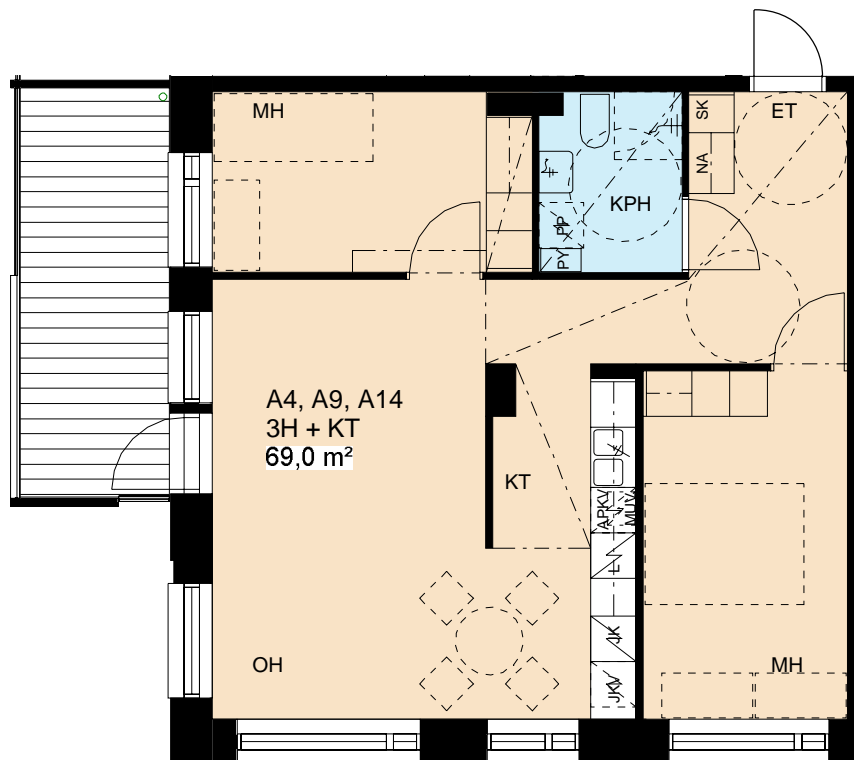
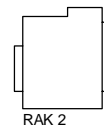
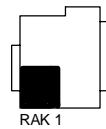
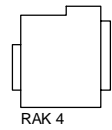
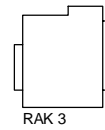

A4 2. KERROS  
A9 3. KERROS  
A14 4. KERROS

VÄHÄISET RAKENNUSAIKAISET MUUTOKSET MAHDOLLISIA

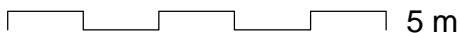

ARKKITEHTITOIMISTO HEDMAN & MATOMÄKI

31.10.2018

# HEKA Risupadontie

Risupadontie 3, 00640

Helsinki

3H + KT 69,0 m<sup>2</sup>

Huoneistopohja 1 : 100

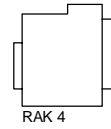
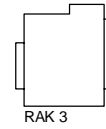

RAK 3

RAK 4

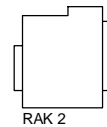
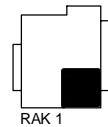

RAK 1

RAK 2

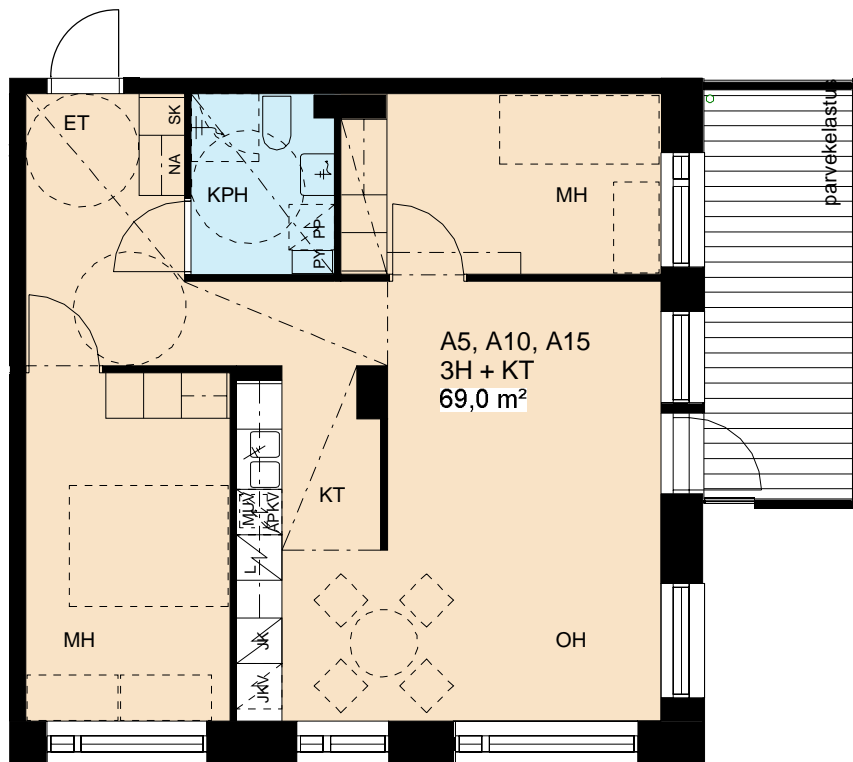

A5 2. KERROS  
A10 3. KERROS  
A15 4. KERROS

VÄHÄISET RAKENNUSAIKAISET MUUTOKSET MAHDOLLISIA



5 m

ARKKITEHTITOIMISTO HEDMAN & MATOMÄKI

31.10.2018

# HEKA Risupadontie

Risupadontie 3, 00640 Helsinki

1H + TK 37,0 m<sup>2</sup>

Huoneistopohja 1 : 100

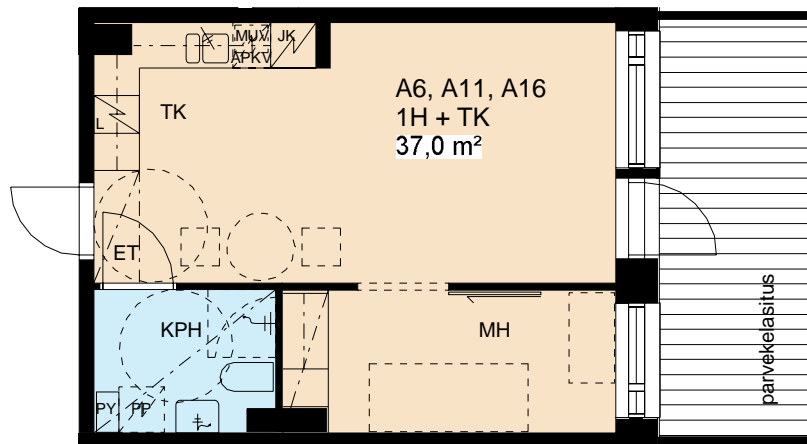
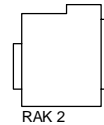
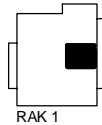
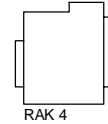
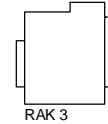

A6 2. KERROS  
A11 3. KERROS  
A16 4. KERROS

VÄHÄISET RAKENNUSAIKAISET MUUTOKSET MAHDOLLISIA



ARKKITEHTITOIMISTO HEDMAN & MATOMÄKI

31.10.2018

# HEKA Risupadontie

Risupadontie 3, 00640 Helsinki

1H + TK 47,5 m<sup>2</sup>

Huoneistopohja 1 : 100

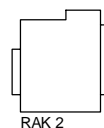
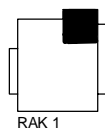
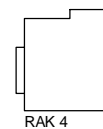
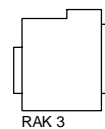

RAK 1

RAK 2

RAK 3

RAK 4

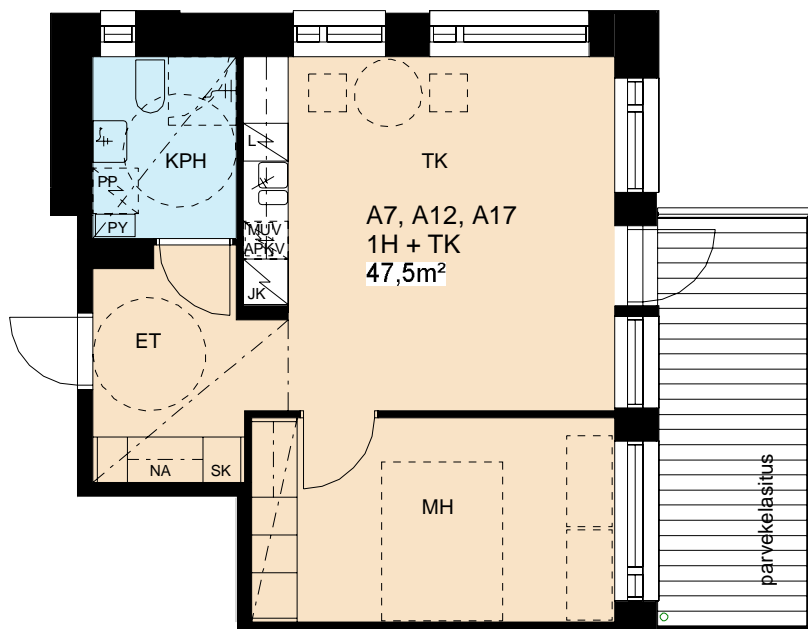

A7 2. KERROS  
A12 3. KERROS  
A17 4. KERROS

VÄHÄISET RAKENNUSAIKAISET MUUTOKSET MAHDOLLISIA



5 m

ARKKITEHTITOIMISTO HEDMAN & MATOMÄKI

31.10.2018

**HEKA Risupadontie**

Risupadontie 3, 00640 Helsinki

3H + KT 74,0 m<sup>2</sup>

Huoneistopohja 1 : 100

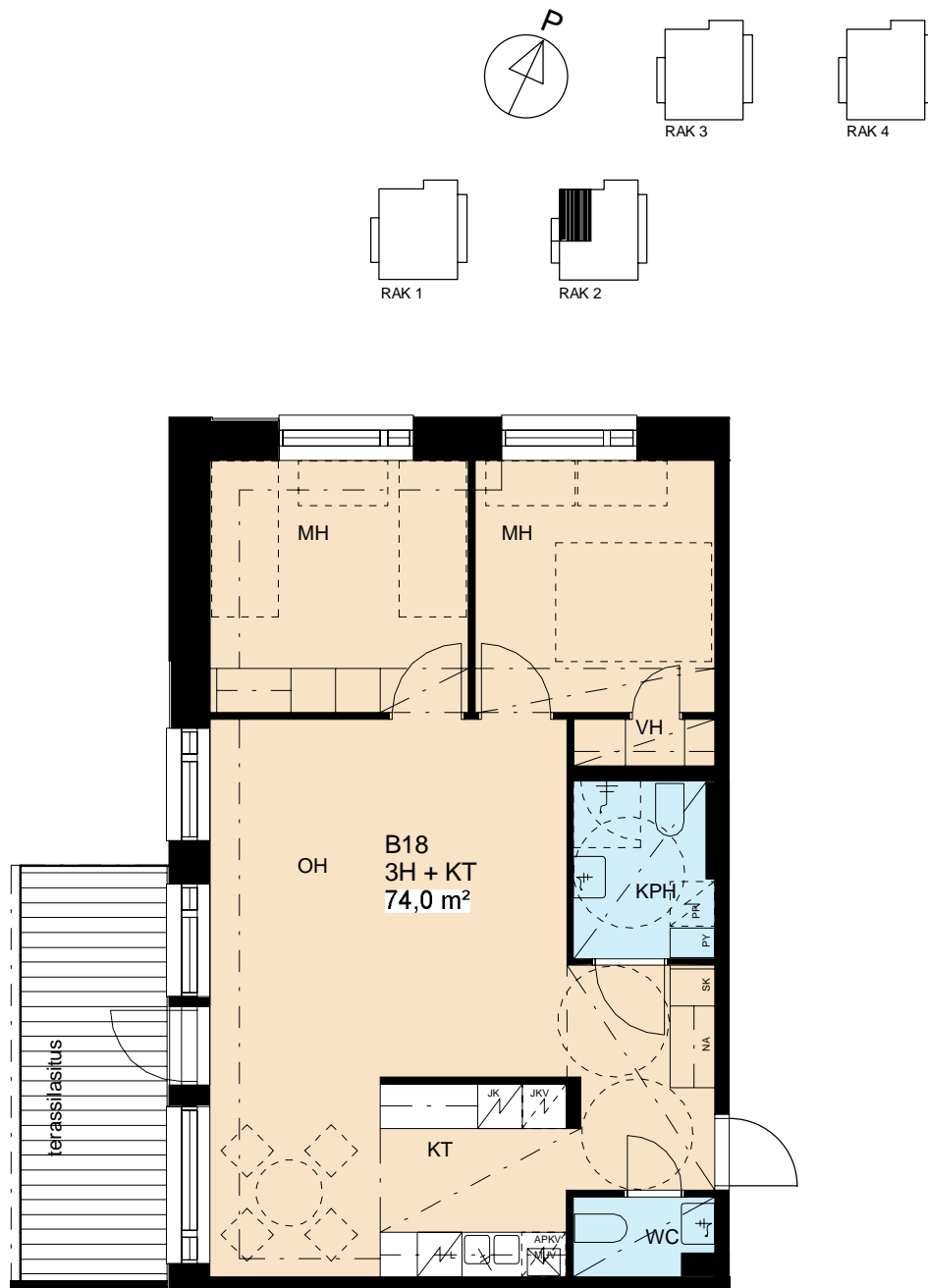

B18, 1. KERROS

VÄHÄISET RAKENNUSAIKAISET MUUTOKSET MAHDOLLISIA



ARKKITEHTITOIMISTO HEDMAN & MATOMÄKI



31.10.2018

# HEKA Risupadontie

Risupadontie 3, 00640 Helsinki

3H + KT 69,5 m<sup>2</sup>

Huoneistopohja 1 : 100

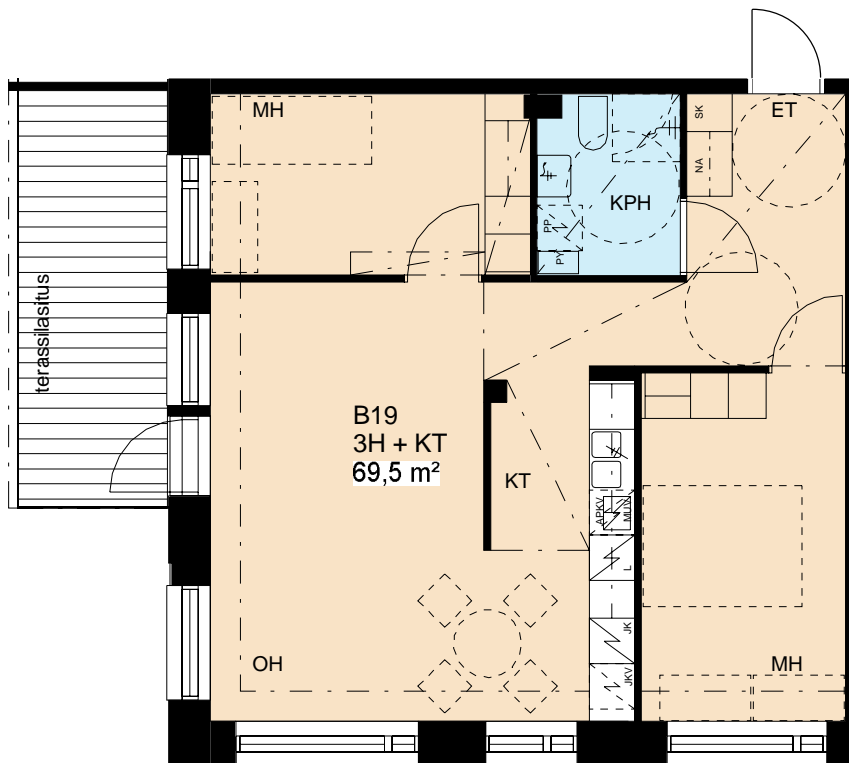
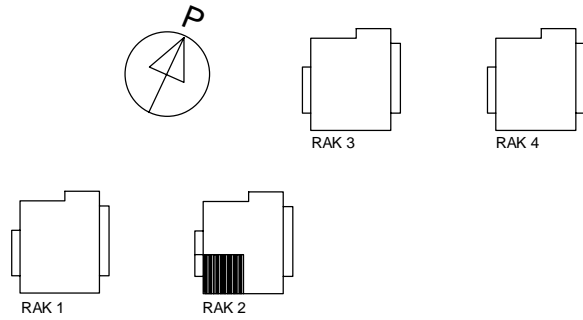

B19, 1. KERROS

VÄHÄISET RAKENNUSAIKAISET MUUTOKSET MAHDOLLISIA



ARKKITEHTITOIMISTO HEDMAN & MATOMÄKI

31.10.2018

# HEKA Risupadontie

Risupadontie 3, 00640 Helsinki

3H + KT 74,0 m<sup>2</sup>

Huoneistopohja 1 : 100

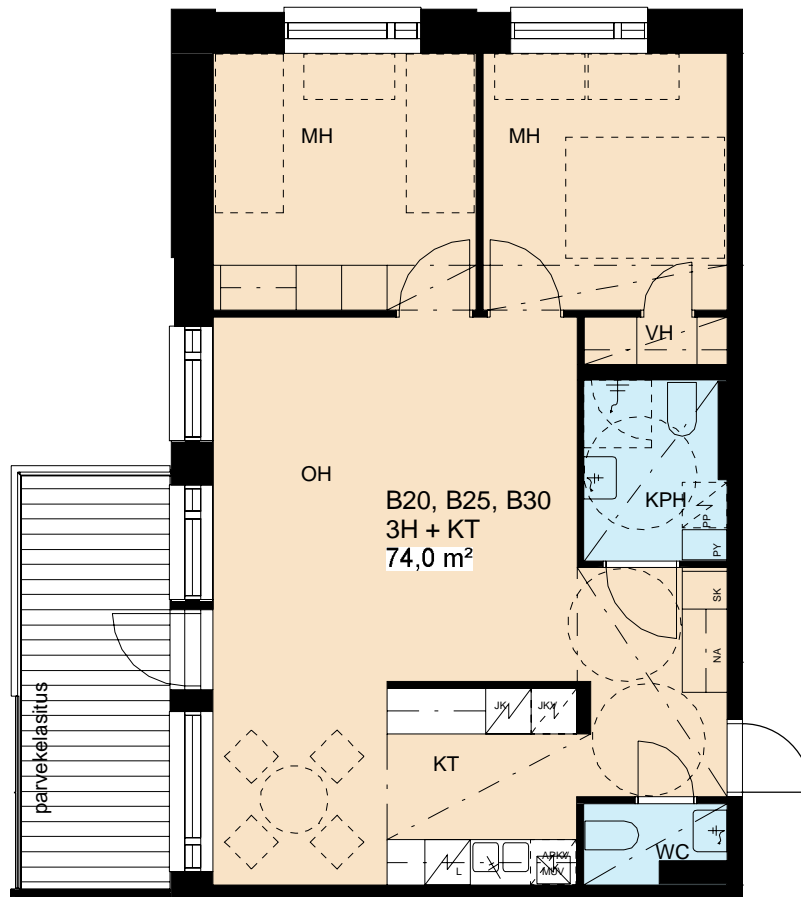
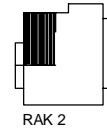
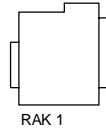
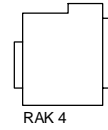
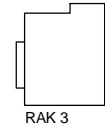

B20, 2. KERROS  
B25, 3. KERROS  
B30, 4. KERROS

VÄHÄISET RAKENNUSAIKAISET MUUTOKSET MAHDOLLISIA



ARKKITEHTITOIMISTO HEDMAN & MATOMÄKI

31.10.2018

# HEKA Risupadontie

Risupadontie 3, 00640 Helsinki

3H + KT 69,0 m<sup>2</sup>

Huoneistopohja 1 : 100

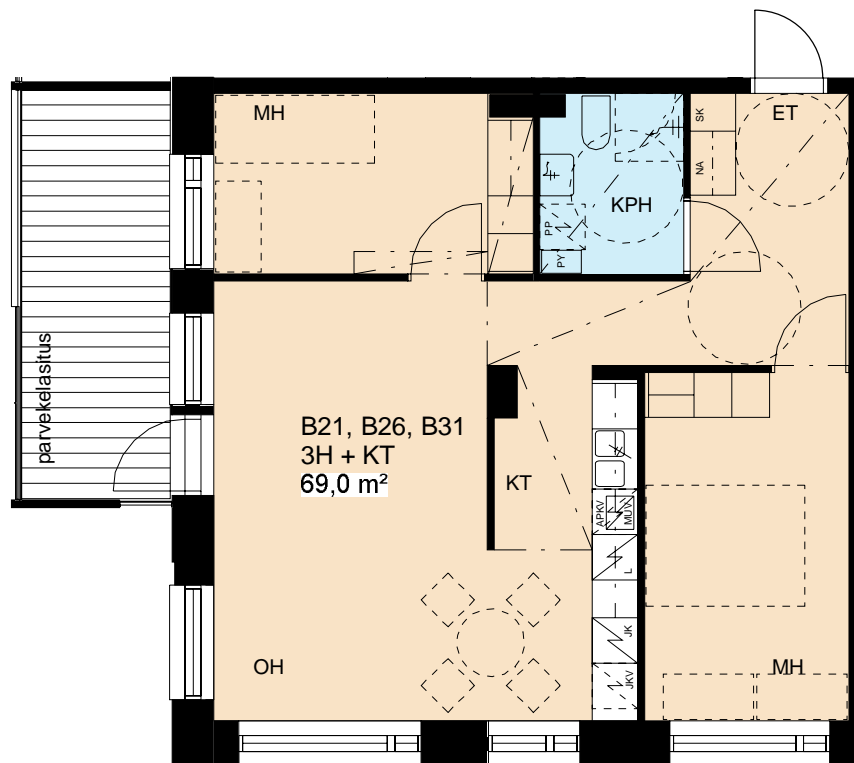
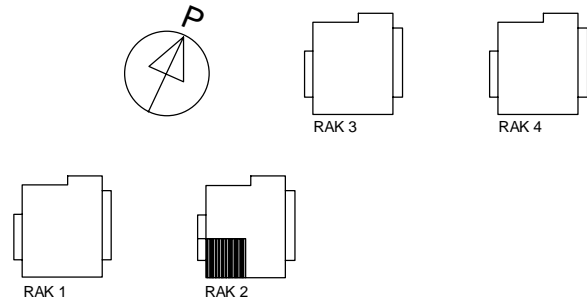

B21, 2. KERROS  
B26, 3. KERROS  
B31, 4. KERROS

VÄHÄISET RAKENNUSAIKAISET MUUTOKSET MAHDOLLISIA  
5 m

ARKKITEHTITOIMISTO HEDMAN & MATOMÄKI

31.10.2018

# HEKA Risupadontie

Risupadontie 3, 00640 Helsinki

3H + KT 69,0 m<sup>2</sup>

Huoneistopohja 1 : 100

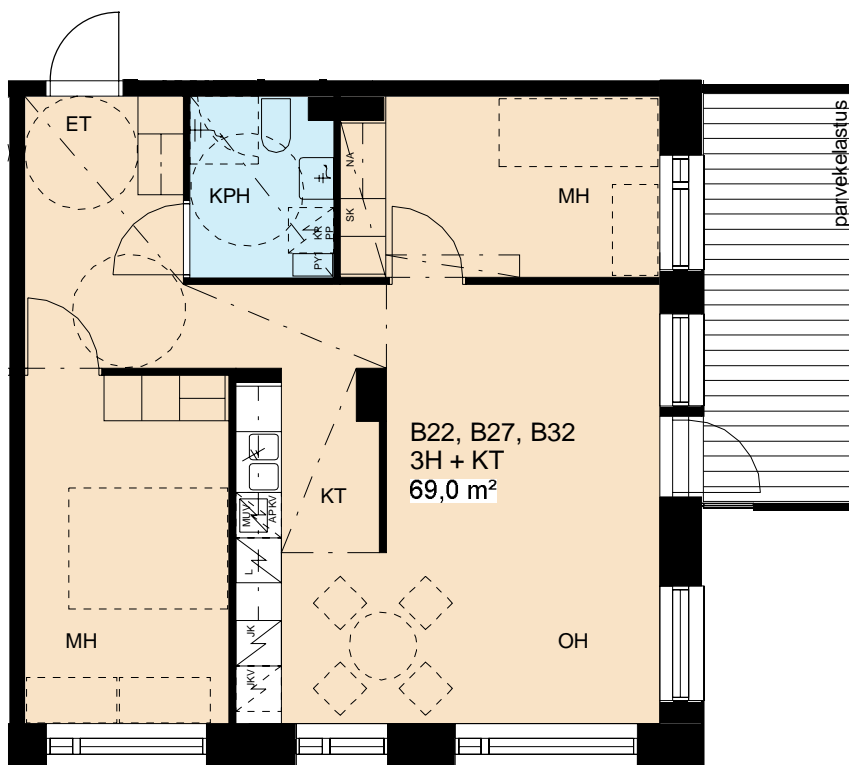
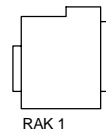
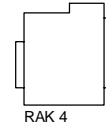
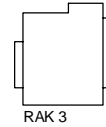

B22, 2. KERROS  
B27, 3. KERROS  
B32, 4. KERROS

VÄHÄISET RAKENNUSAIKAISET MUUTOKSET MAHDOLLISIA



ARKKITEHTITOIMISTO HEDMAN & MATOMÄKI

31.10.2018

# HEKA Risupadontie

Risupadontie 3, 00640 Helsinki

1H + TK 36,5 m<sup>2</sup>

Huoneistopohja 1 : 100

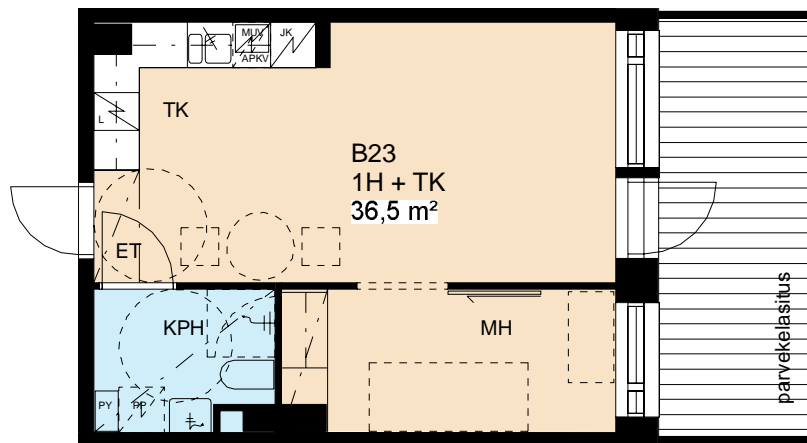
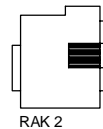
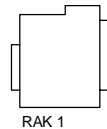
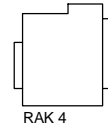
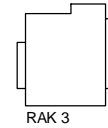

B23, 2. KERROS

VÄHÄISET RAKENNUSAIKAISET MUUTOKSET MAHDOLLISIA



ARKKITEHTITOIMISTO HEDMAN & MATOMÄKI

31.10.2018

# HEKA Risupadontie

Risupadontie 3, 00640

Helsinki

1H + TK 47,5 m<sup>2</sup>

Huoneistopohja 1 : 100

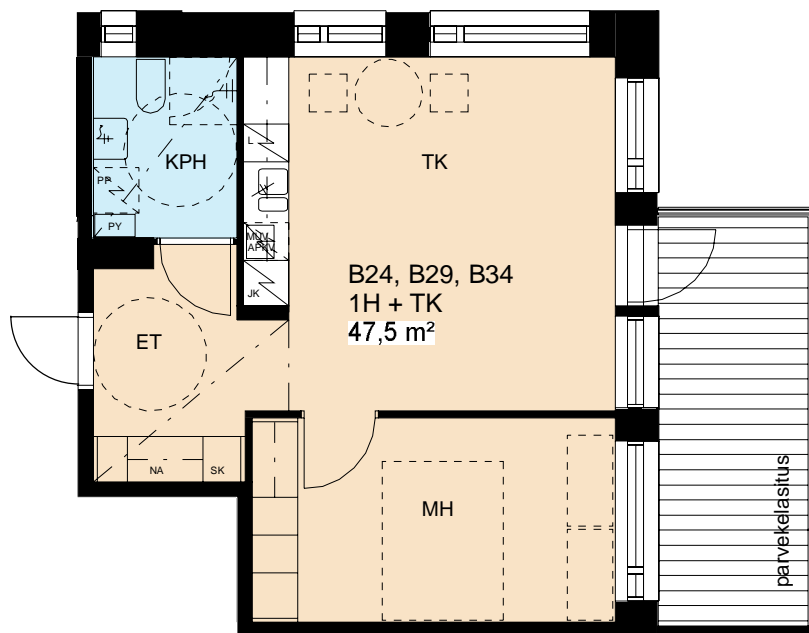
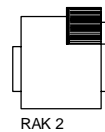
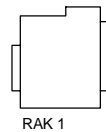
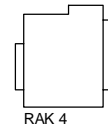
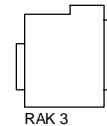

B24, 2. KERROS  
B29, 3. KERROS  
B34, 4. KERROS

VÄHÄISET RAKENNUSAIKAISET MUUTOKSET MAHDOLLISIA



ARKKITEHTITOIMISTO HEDMAN & MATOMÄKI

31.10.2018

**HEKA Risupadontie**

Risupadontie 3, 00640 Helsinki

1H + TK 36,5 m<sup>2</sup>

Huoneistopohja 1 : 100

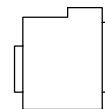
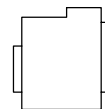

RAK 3

RAK 4

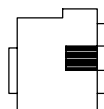
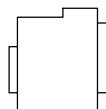

RAK 1

RAK 2

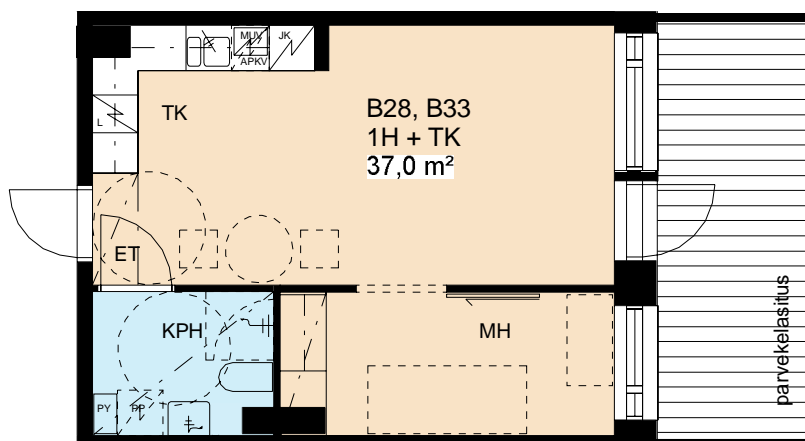

B28, 3. KERROS  
B33, 4. KERROS

VÄHÄISET RAKENNUSAIKAISET MUUTOKSET MAHDOLLISIA



5 m

ARKKITEHTITOIMISTO HEDMAN & MATOMÄKI

31.10.2018

# HEKA Risupadontie

Risupadontie 3, 00640 Helsinki

1H + TK 51,5 m<sup>2</sup>

Huoneistopohja 1 : 100

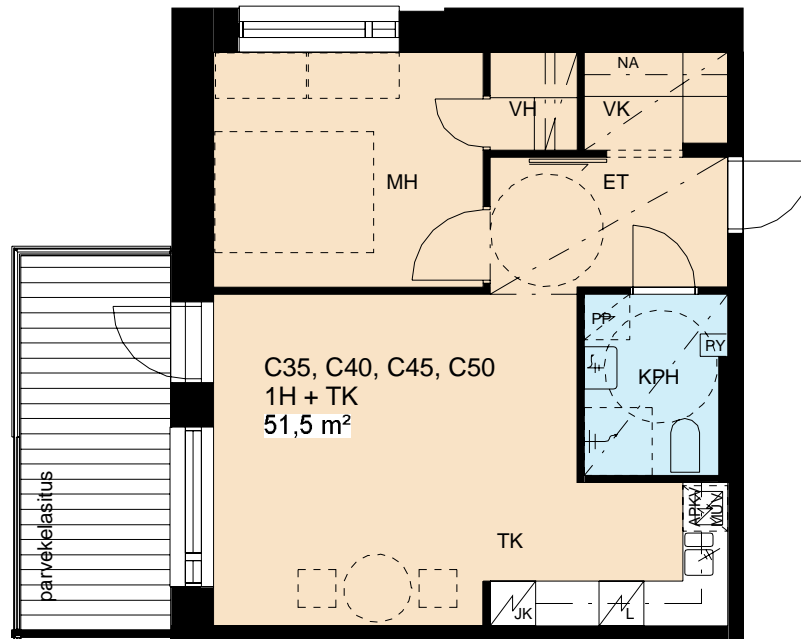
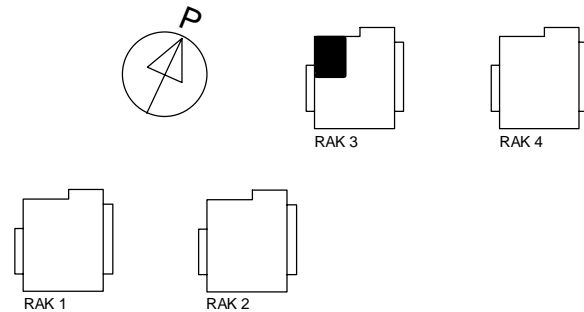

C35, 2. KERROS  
C40, 3. KERROS  
C45, 4. KERROS  
C50, 5. KERROS

VÄHÄISET RAKENNUSAIKAISET MUUTOKSET MAHDOLLISIA



ARKKITEHTITOIMISTO HEDMAN & MATOMÄKI



31.10.2018

# HEKA Risupadontie

Risupadontie 3, 00640 Helsinki

4H + K 92,0 m<sup>2</sup>

Huoneistopohja 1 : 100

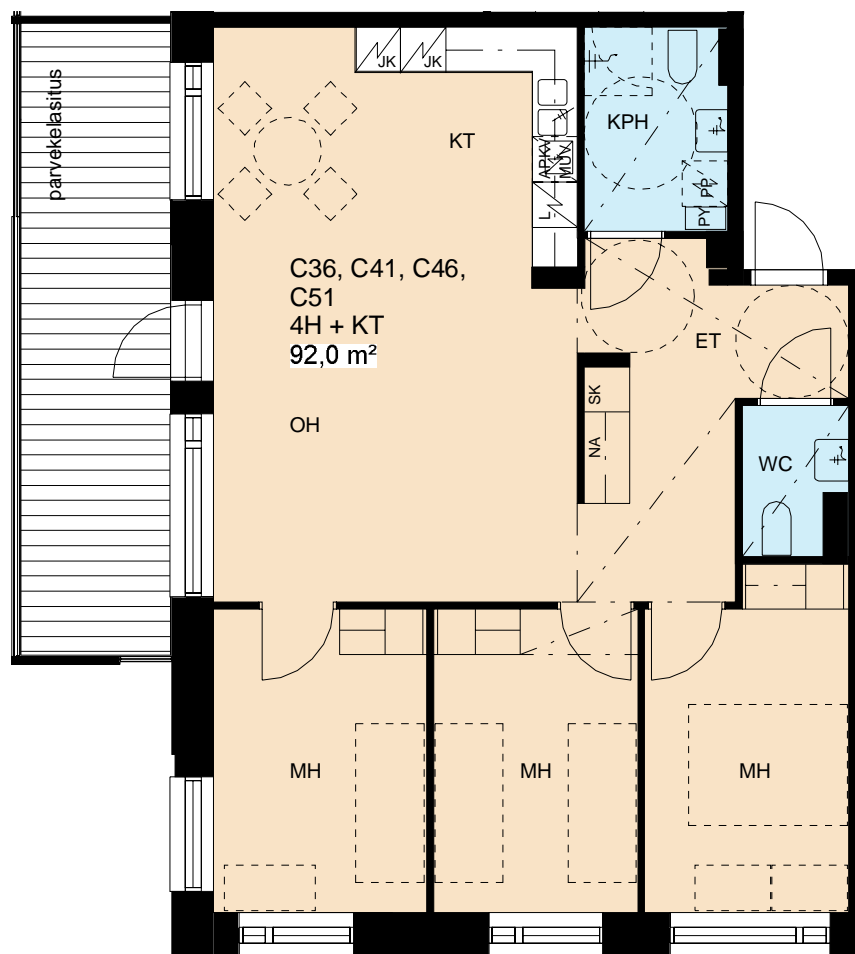
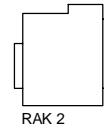
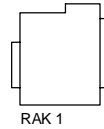
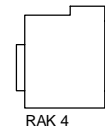
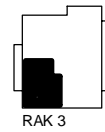

C36, 2. KERROS  
C41, 3. KERROS  
C46, 4. KERROS  
C51, 5. KERROS

VÄHÄISET RAKENNUSAIKAISET MUUTOKSET MAHDOLLISIA



ARKKITEHTITOIMISTO HEDMAN & MATOMÄKI

31.10.2018

# HEKA Risupadontie

Risupadontie 3, 00640 Helsinki

3H + KT 69,0 m<sup>2</sup>

Huoneistopohja 1 : 100



- C37, 2. KERROS
- C42, 3. KERROS
- C47, 4. KERROS
- C52, 5. KERROS

VÄHÄISET RAKENNUSAIKAISET MUUTOKSET MAHDOLLISIA



ARKKITEHTITOIMISTO HEDMAN & MATOMÄKI

31.10.2018

# HEKA Risupadontie

Risupadontie 3, 00640 Helsinki

1H + TK 37,0 m<sup>2</sup>

Huoneistopohja 1 : 100

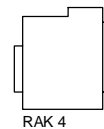
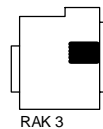

RAK 3

RAK 4

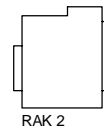
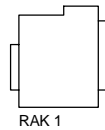

RAK 1

RAK 2

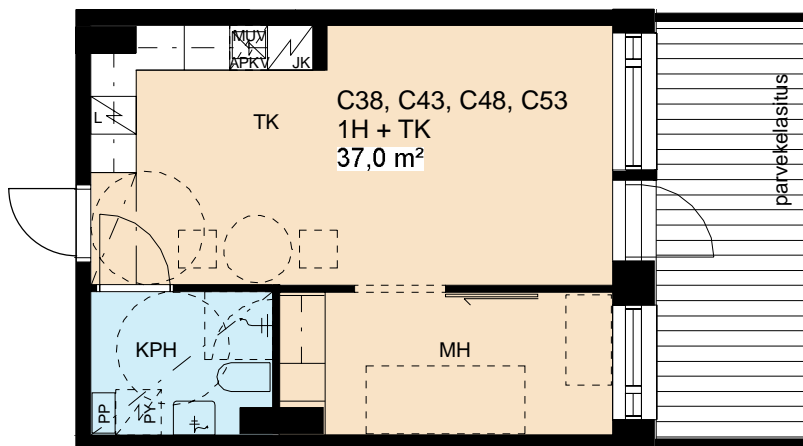

C38, 2. KERROS  
C43, 3. KERROS  
C48, 4. KERROS  
C53, 5. KERROS

VÄHÄISET RAKENNUSAIKAISET MUUTOKSET MAHDOLLISIA



5 m

ARKKITEHTITOIMISTO HEDMAN & MATOMÄKI

31.10.2018

# HEKA Risupadontie

Risupadontie 3, 00640 Helsinki

1H + TK 47,5 m<sup>2</sup>

Huoneistopohja 1 : 100

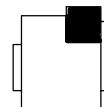

RAK 3

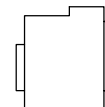

RAK 4

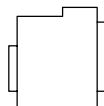

RAK 1

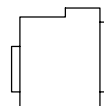

RAK 2

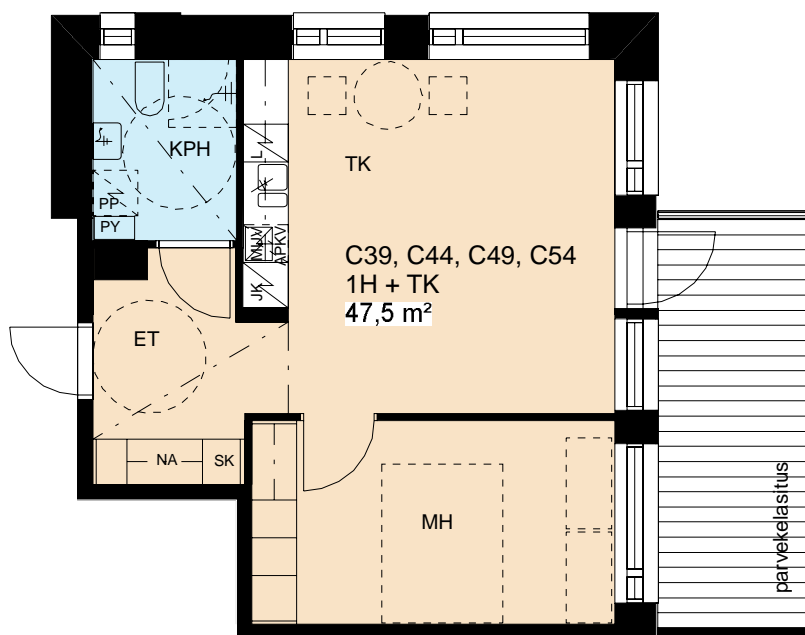

- C39, 2. KERROS
- C44, 3. KERROS
- C49, 4. KERROS
- C54, 5. KERROS

VÄHÄISET RAKENNUSAIKAISET MUUTOKSET MAHDOLLISIA



5 m

ARKKITEHTITOIMISTO HEDMAN & MATOMÄKI

31.10.2018

# HEKA Risupadontie

Risupadontie 3, 00640 Helsinki

3H + KT 74,5 m<sup>2</sup>

Huoneistopohja 1 : 100

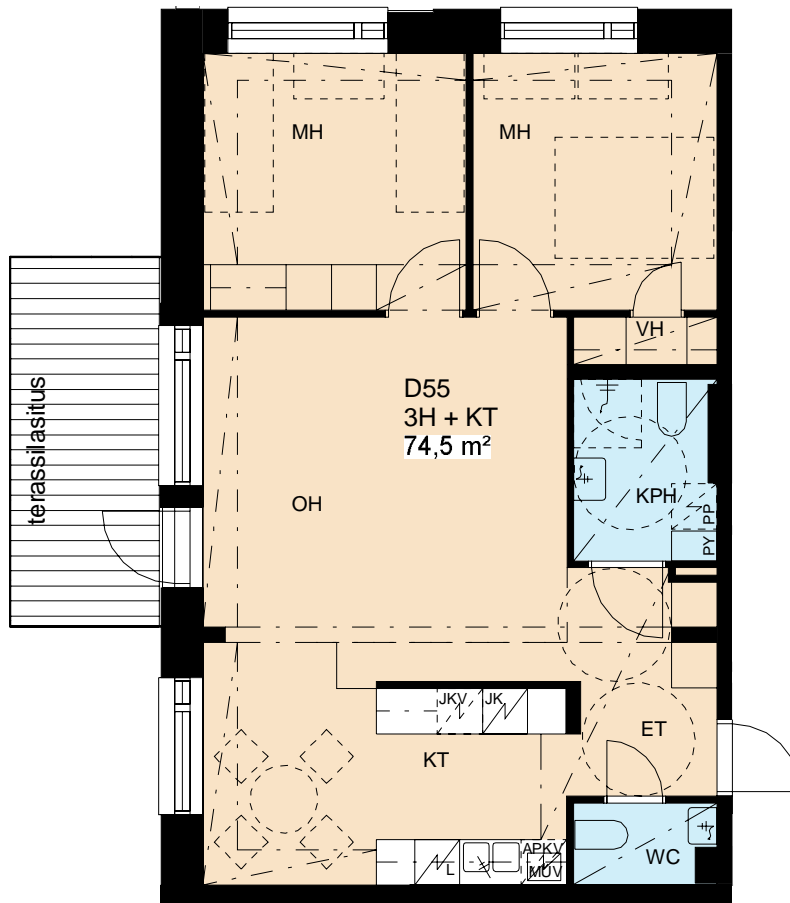
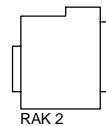
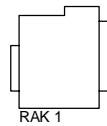
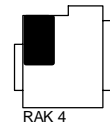
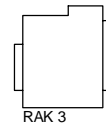

D55 1. KERROS

VÄHÄISET RAKENNUSAIKAISET MUUTOKSET MAHDOLLISIA



ARKKITEHTITOIMISTO HEDMAN & MATOMÄKI

31.10.2018

# HEKA Risupadontie

Risupadontie 3, 00640 Helsinki

1H + TK 51,5 m<sup>2</sup>

Huoneistopohja 1 : 100

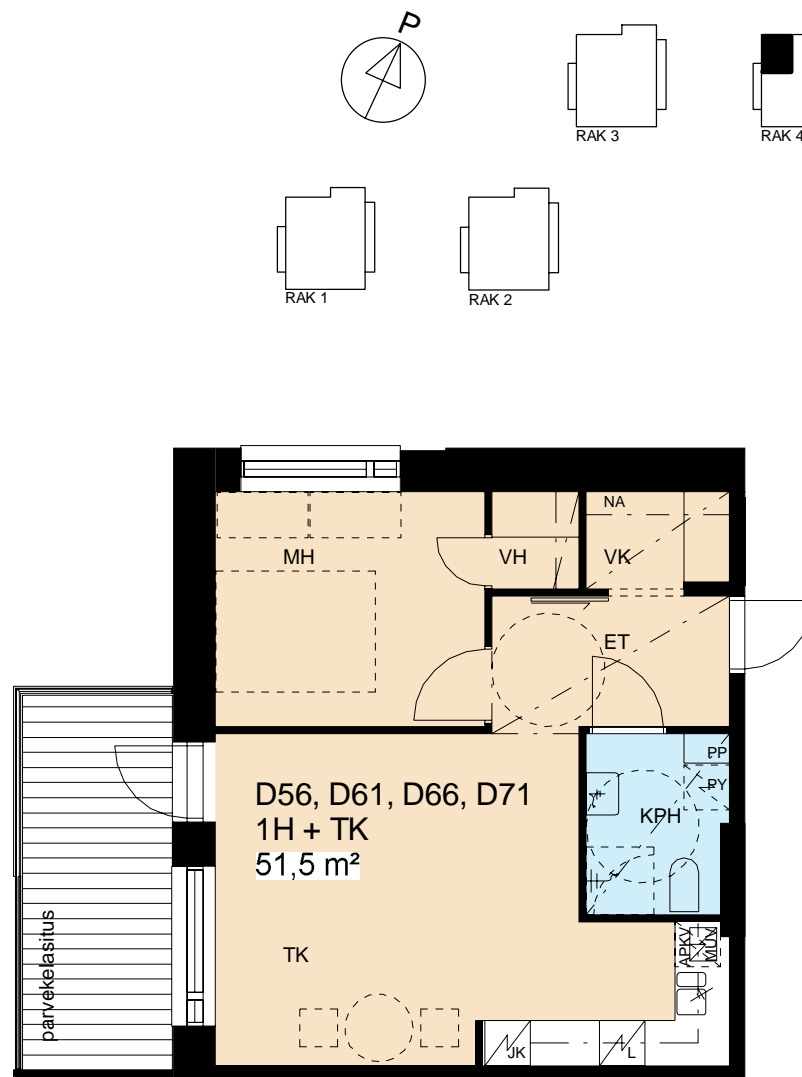

- D56 2. KERROS
- D61 3. KERROS
- D66 4. KERROS
- D71 5. KERROS

VÄHÄISET RAKENNUSAIKAISET MUUTOKSET MAHDOLLISIA



ARKKITEHTITOIMISTO HEDMAN & MATOMÄKI

31.10.2018

# HEKA Risupadontie

Risupadontie 3, 00640 Helsinki

4H + K 92,0 m<sup>2</sup>

Huoneistopohja 1 : 100

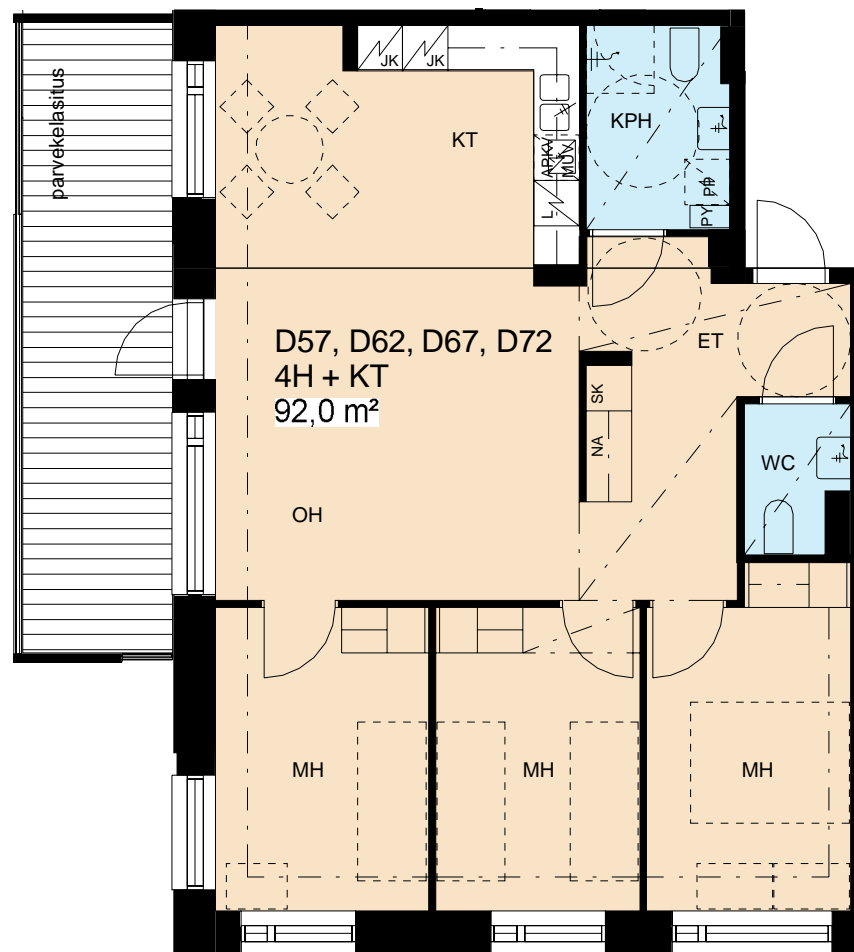
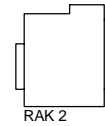
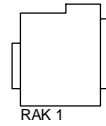
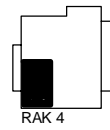
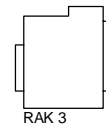

- D57 2. KERROS
- D62 3. KERROS
- D67 4. KERROS
- D72 5. KERROS

VÄHÄISET RAKENNUSAIKAISET MUUTOKSET MAHDOLLISIA  
 5 m

ARKKITEHTITOIMISTO HEDMAN & MATOMÄKI

31.10.2018

# HEKA Risupadontie

Risupadontie 3, 00640 Helsinki

3H + KT 69,0 m<sup>2</sup>

Huoneistopohja 1 : 100

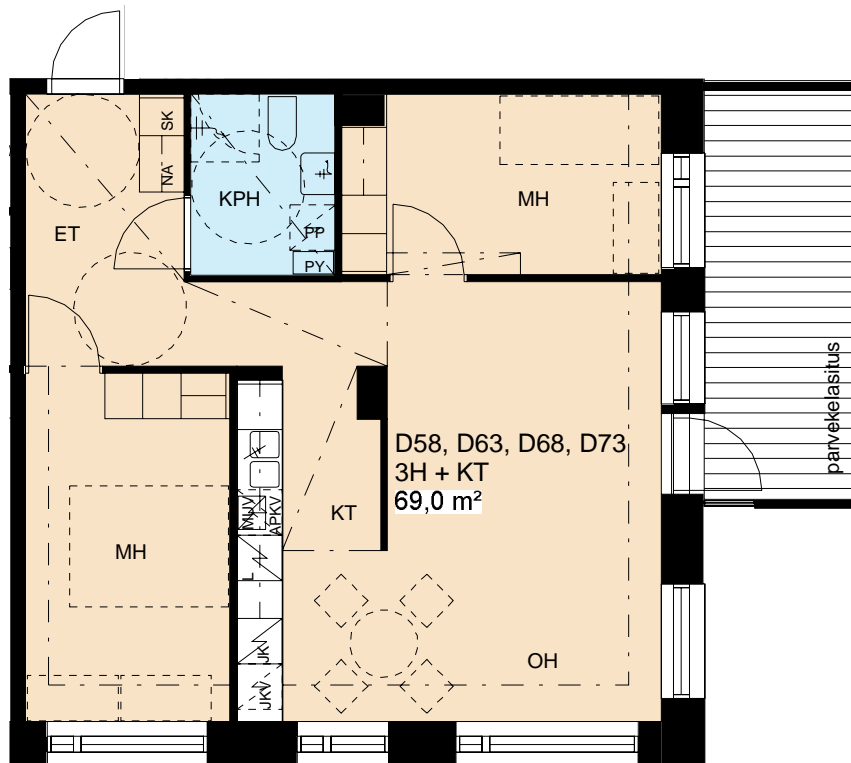
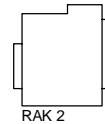
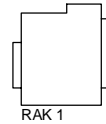
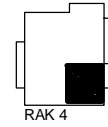
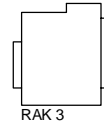

- D58 2. KERROS
- D63 3. KERROS
- D68 4. KERROS
- D73 5. KERROS

VÄHÄISET RAKENNUSAIKAISET MUUTOKSET MAHDOLLISIA



ARKKITEHTITOIMISTO HEDMAN & MATOMÄKI



31.10.2018

# HEKA Risupadontie

Risupadontie 3, 00640 Helsinki

1H + TK 37,0 m<sup>2</sup>

Huoneistopohja 1 : 100

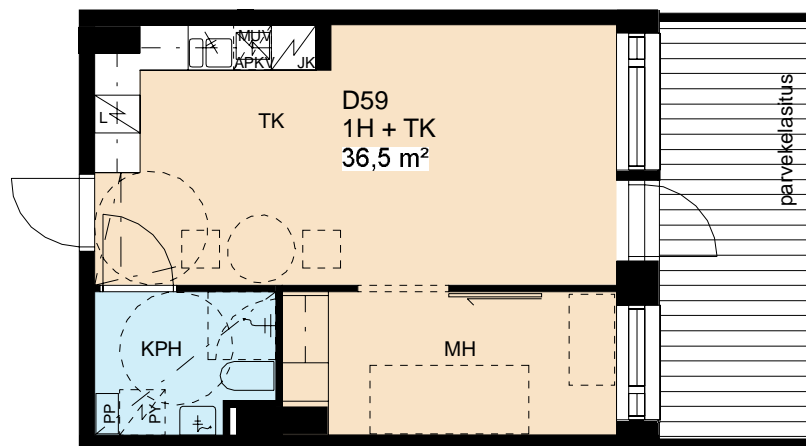
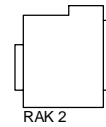
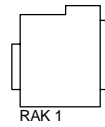
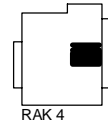
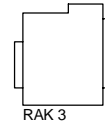

D59 2. KERROS

VÄHÄISET RAKENNUSAIKAISET MUUTOKSET MAHDOLLISIA

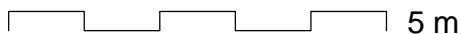

ARKKITEHTITOIMISTO HEDMAN & MATOMÄKI

31.10.2018

# HEKA Risupadontie

Risupadontie 3, 00640 Helsinki

1H + TK 47,5 m<sup>2</sup>

Huoneistopohja 1 : 100

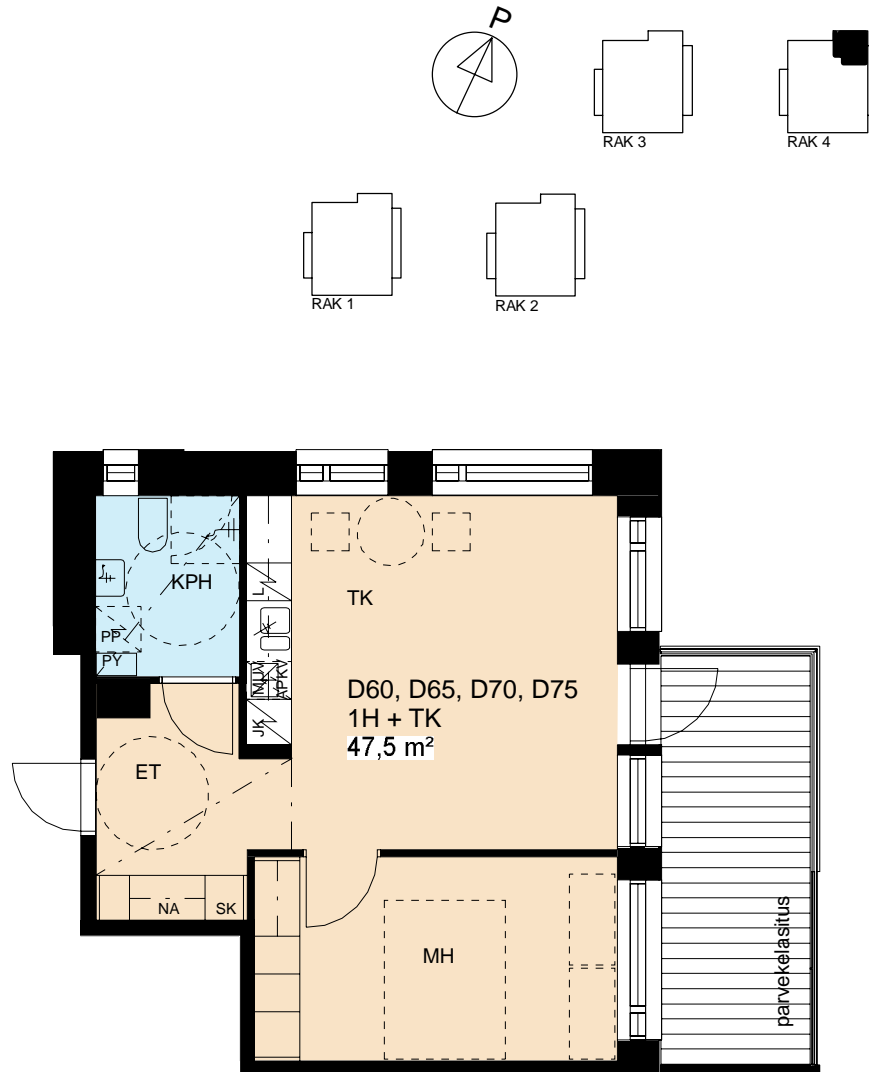

- D60 2. KERROS
- D65 3. KERROS
- D70 4. KERROS
- D75 5. KERROS

VÄHÄISET RAKENNUSAIKAISET MUUTOKSET MAHDOLLISIA  
 5 m

ARKKITEHTITOIMISTO HEDMAN & MATOMÄKI

31.10.2018

# HEKA Risupadontie

Risupadontie 3, 00640 Helsinki

1H + TK 37,0 m<sup>2</sup>

Huoneistopohja 1 : 100

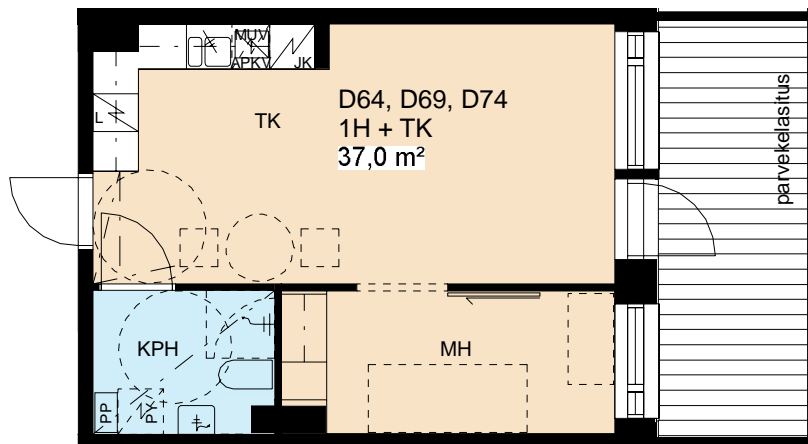
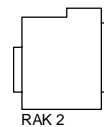
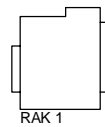
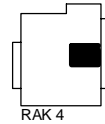
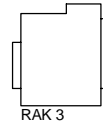

D64 3. KERROS  
D69 4. KERROS  
D74 5. KERROS

VÄHÄISET RAKENNUSAIKAISET MUUTOKSET MAHDOLLISIA  
 5 m

ARKKITEHTITOIMISTO HEDMAN & MATOMÄKI